

Nur für den Dienstgebrauch!

Vorläufiges K Gerätverzeichnis

(gleichzeitig Erlächteilliste)

Kraftfahrgerät

(G. Verz. K)

Teil 3

Fahrgestell und Turm

Panzerkampfwagen „Tiger“

(Sd. Kfz. 181 t 3w. 182)

Ausführung E

Heft 60

Der Chef der Heeresrüstung und Befehlshaber des Ersatzheeres
(AHA/Fz Jn IVe)

Berlin, Juli 1943

TAFEL 1

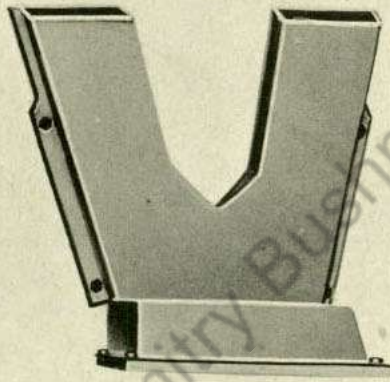
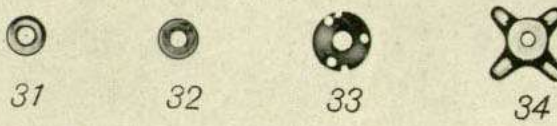
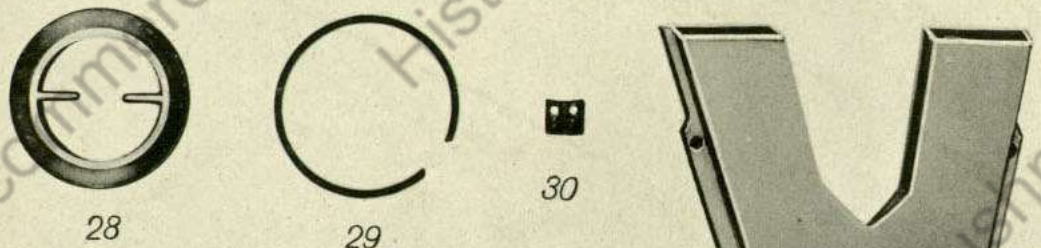
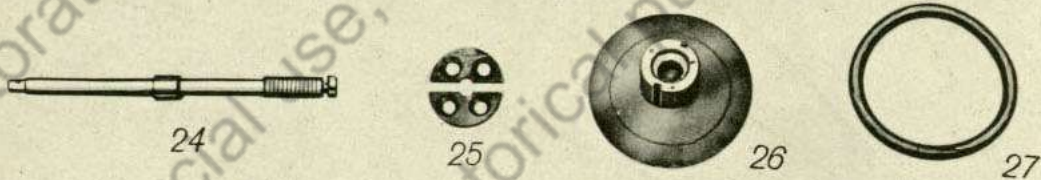
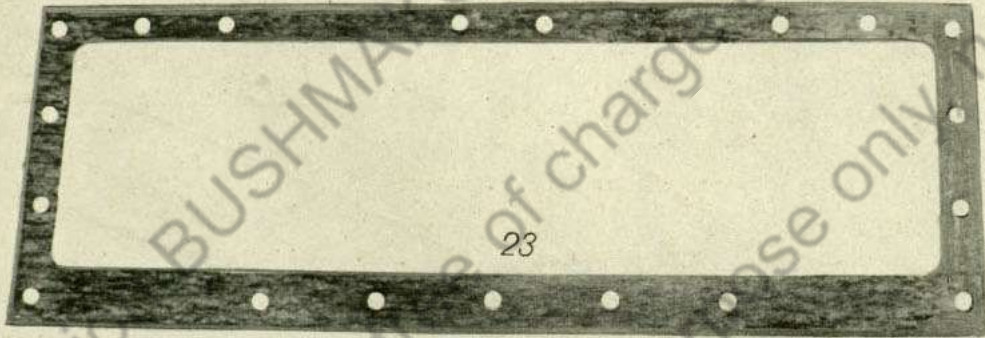
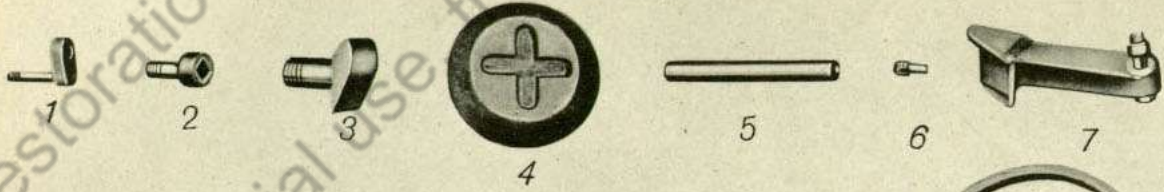

Gruppe: Panzerwanne und Panzerwanneneinbau

TAFEL 2

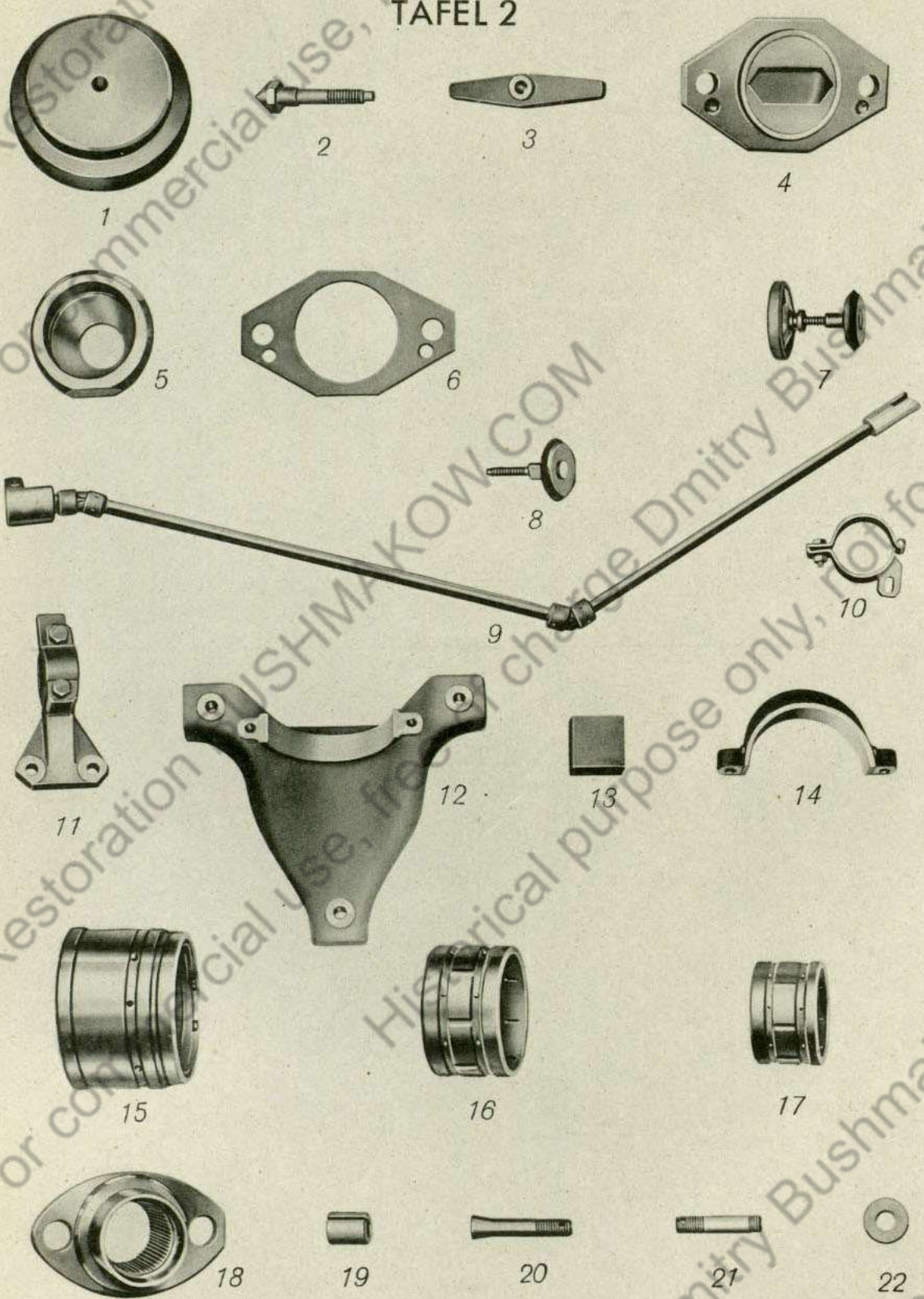

Gruppe: Panzerwanne und Panzerwanneneinbau

TAFEL 3

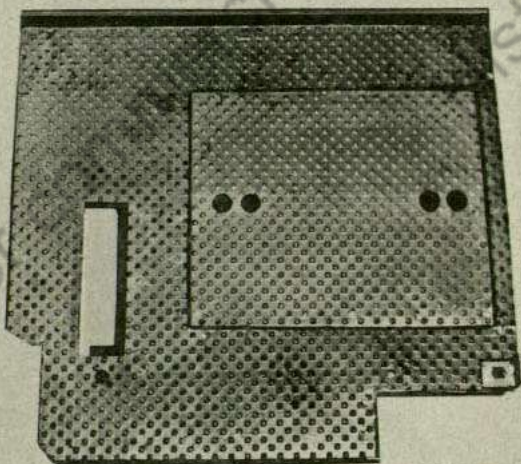
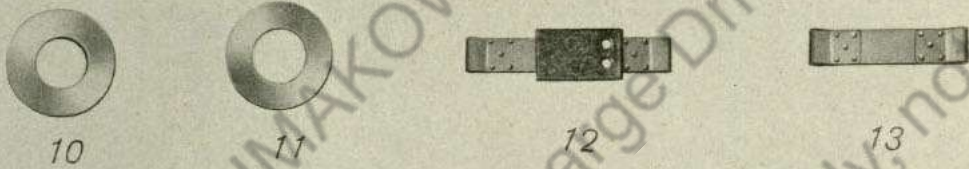
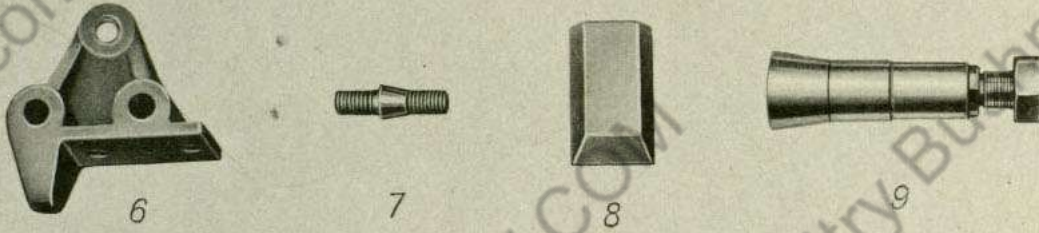
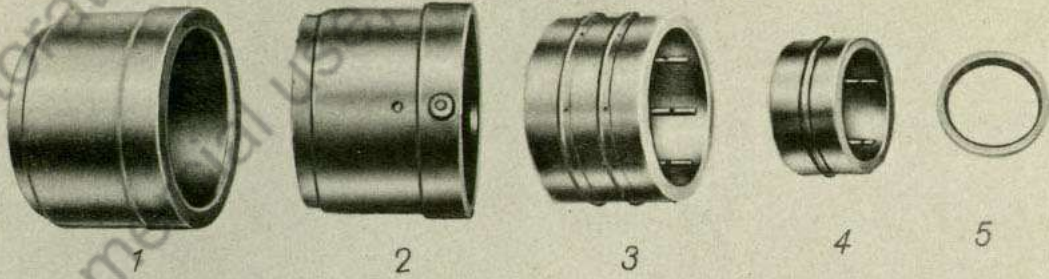

Gruppe: Panzerwanne und Panzerwanneneinbau

TAFEL 4

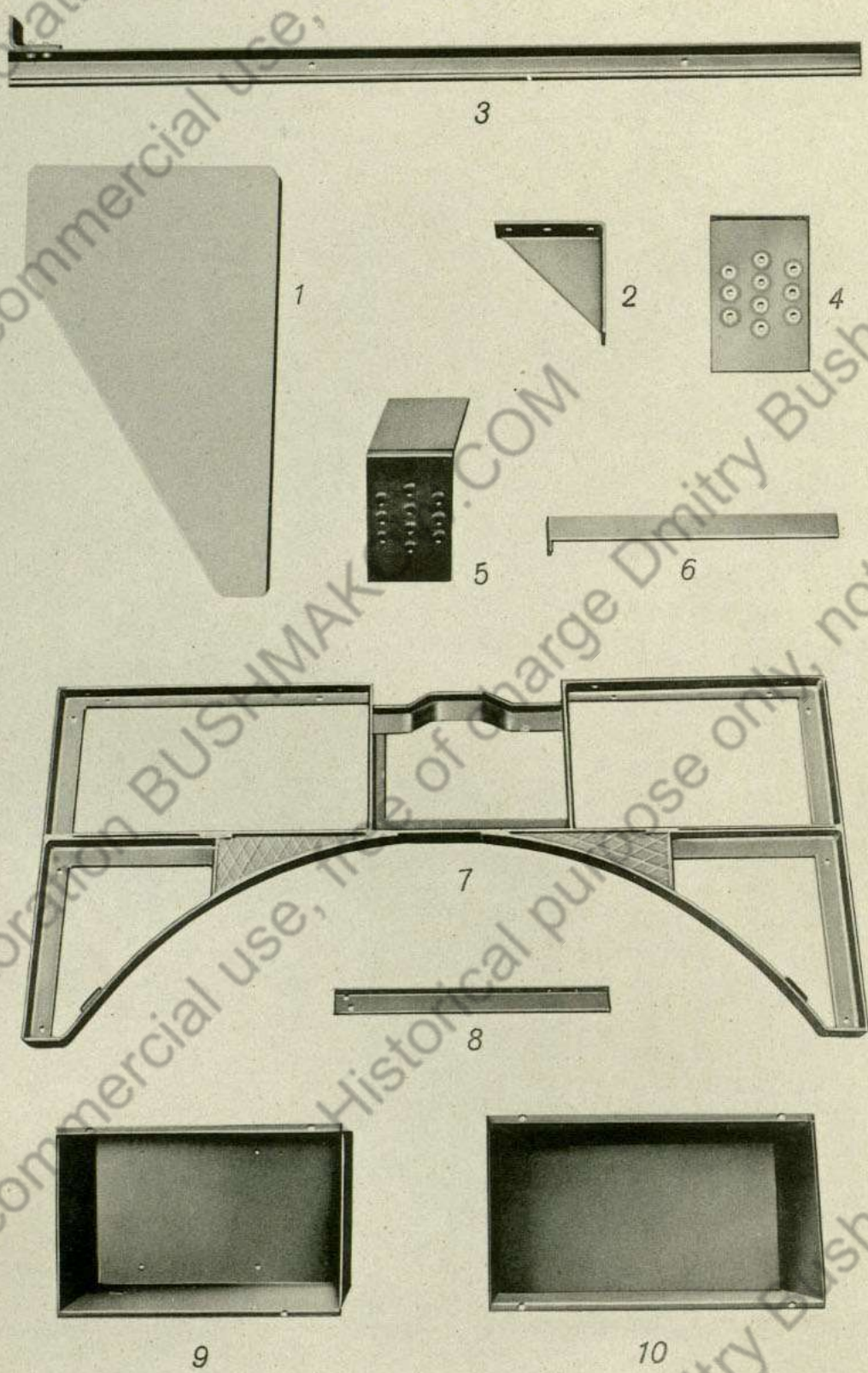

Gruppe: Panzerwanne und Panzerwanneneinbau

TAFEL 5

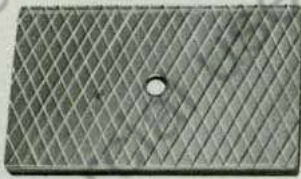

1

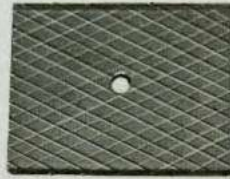

2



3



4

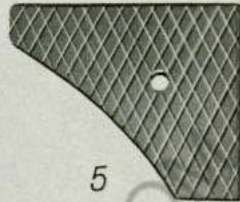

5



6

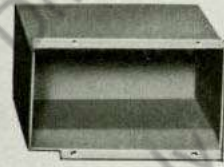

7



8

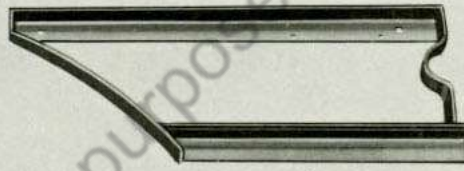

9

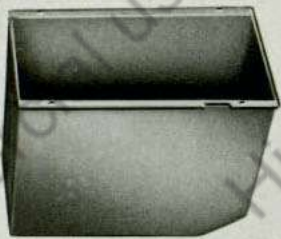

10



11

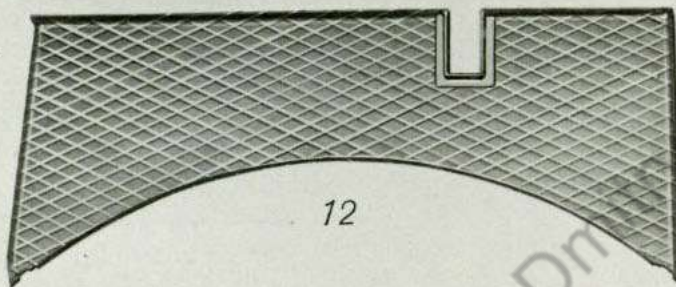

12

Gruppe: Panzerwanne und Panzerwannen-Einbau

TAFEL 6

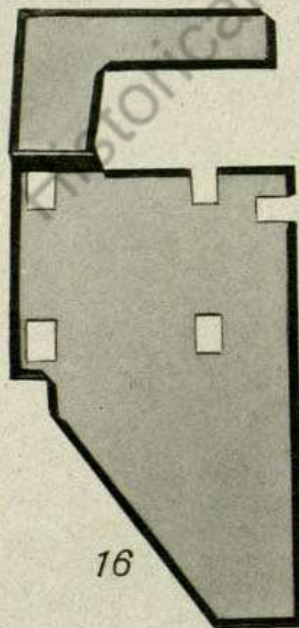
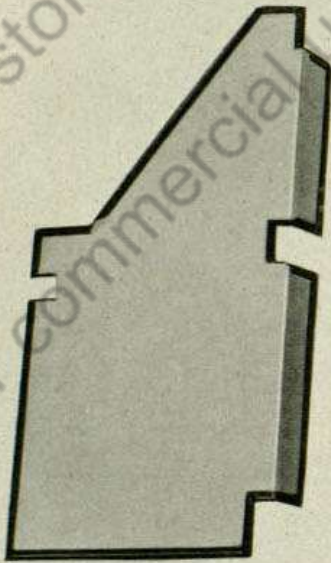
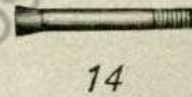
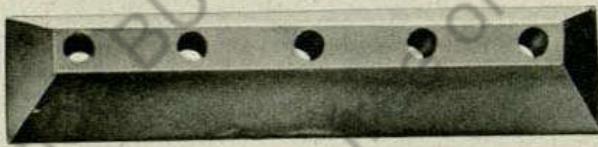
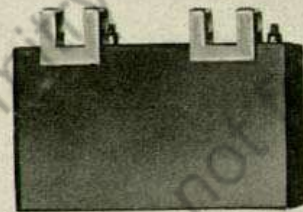
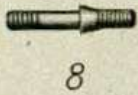
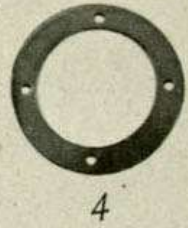
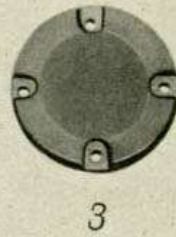

Gruppe: Panzerwanne und Panzerwanneneinbau

TAFEL 7

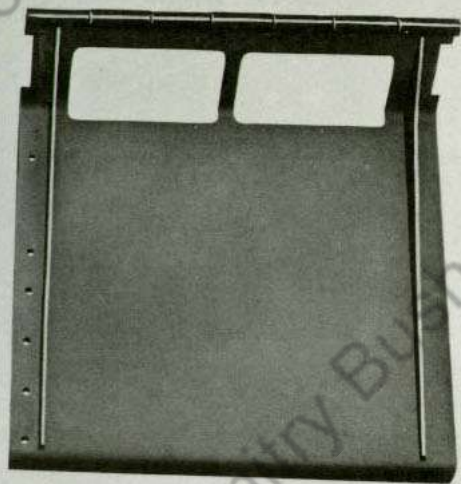
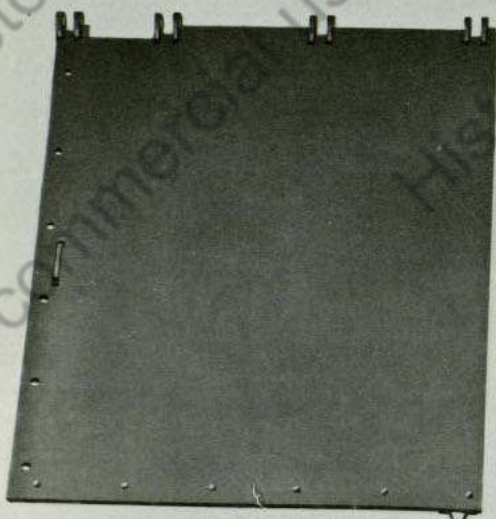
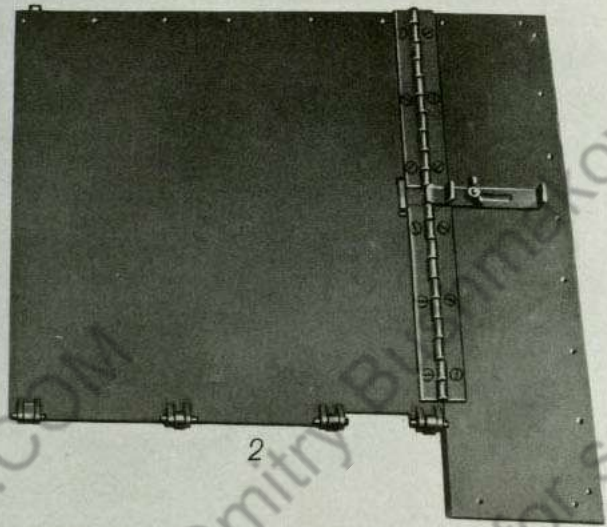
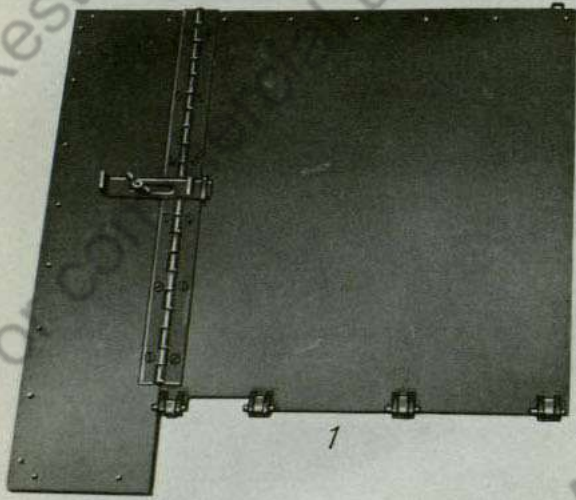

Gruppe: Kettenabdeckung, links und rechts

TAFEL 8



1



2

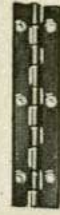

3



4



5



6



7



8

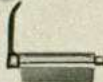

9



10



11

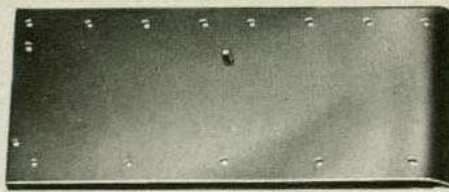

12



13



14

Gruppe: Kettenabdeckung links und rechts

TAFEL 9

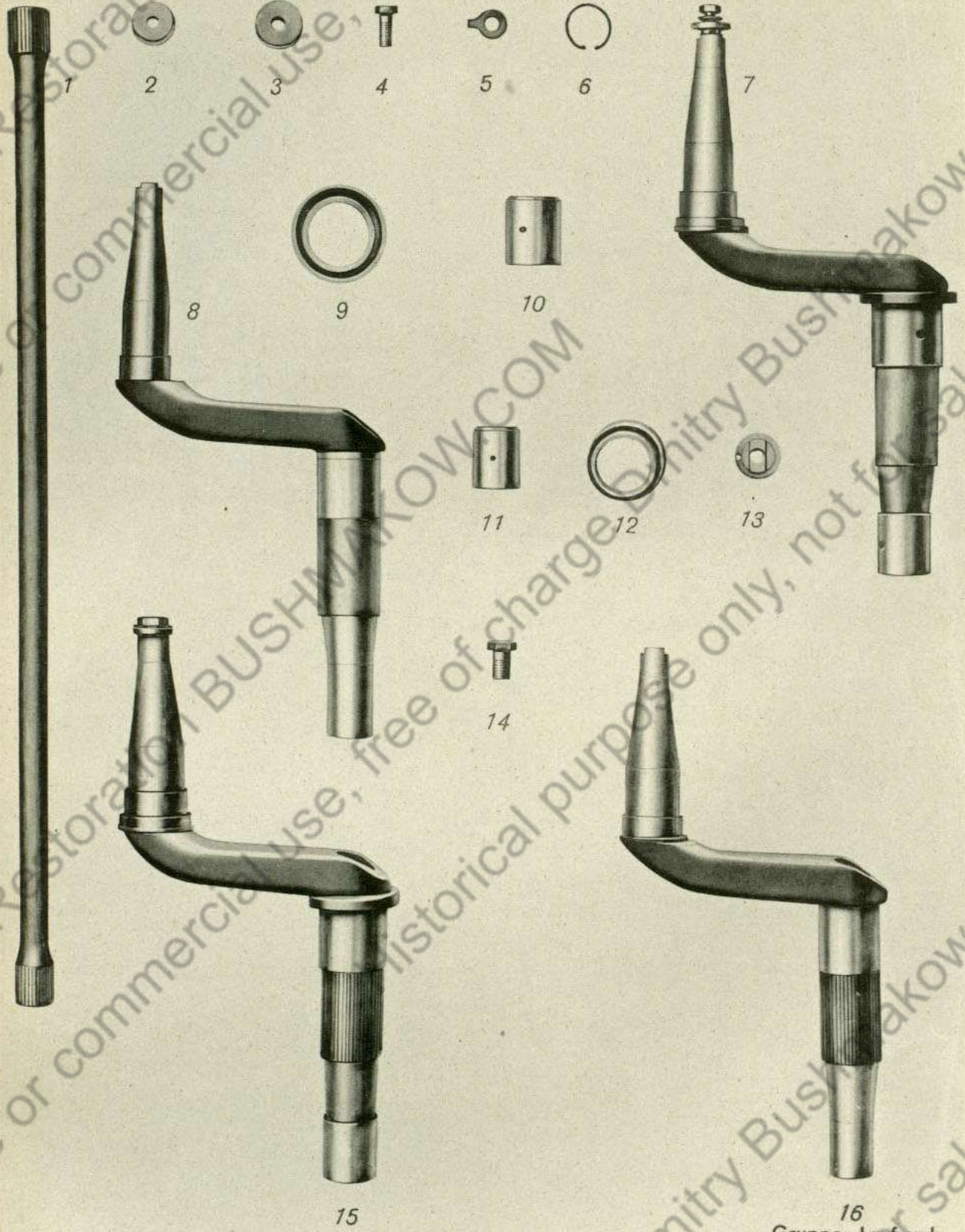

Gruppe: Laufwerk

TAFEL 10

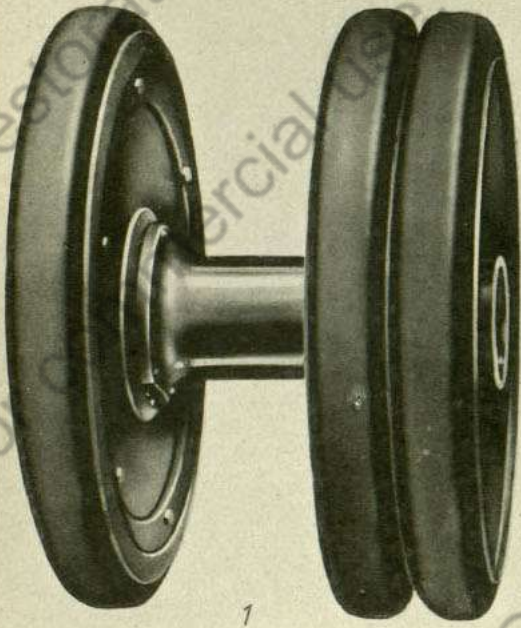

1

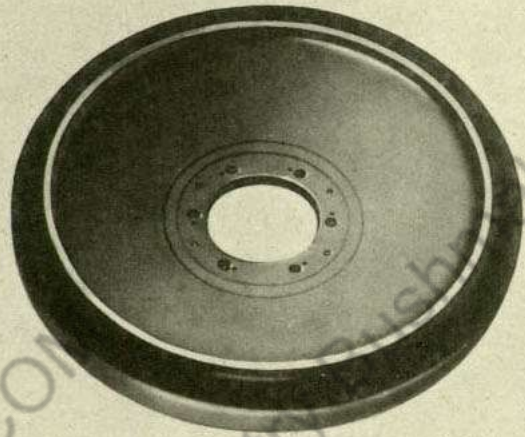

2

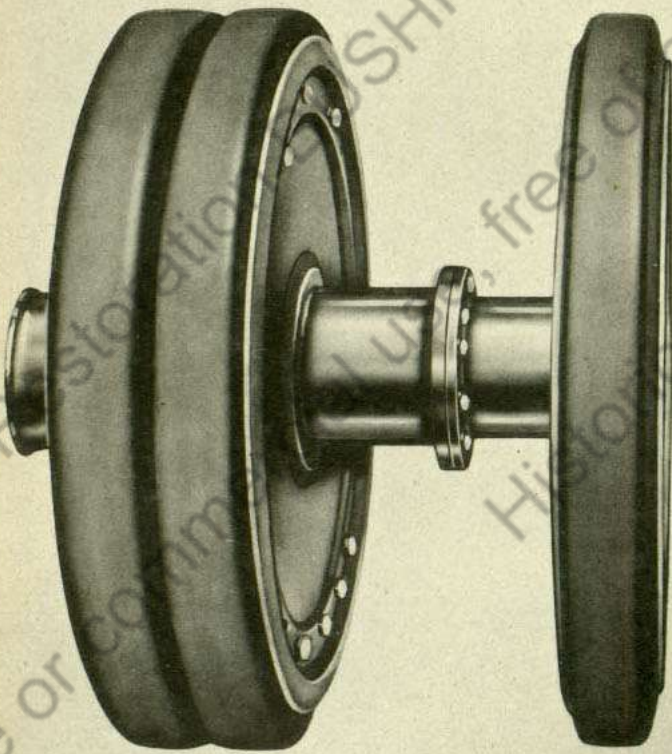

3

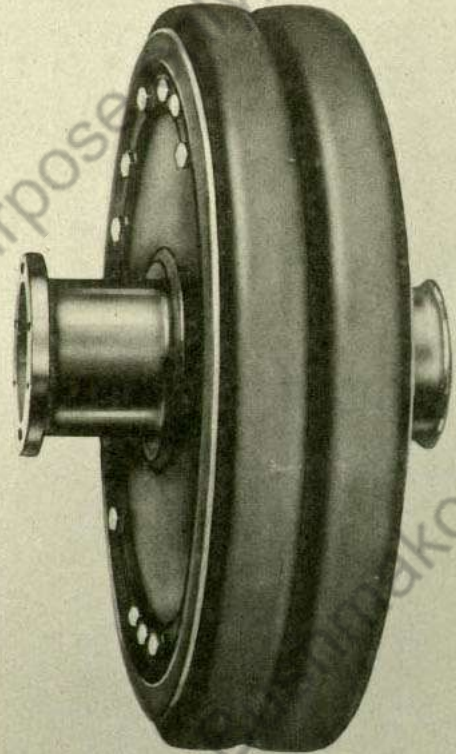

4

Gruppe: Laufwerk

TAFEL 11

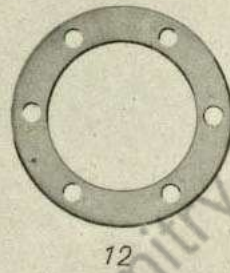
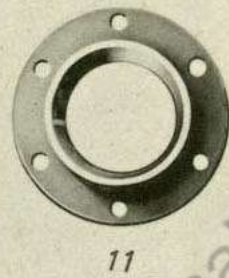
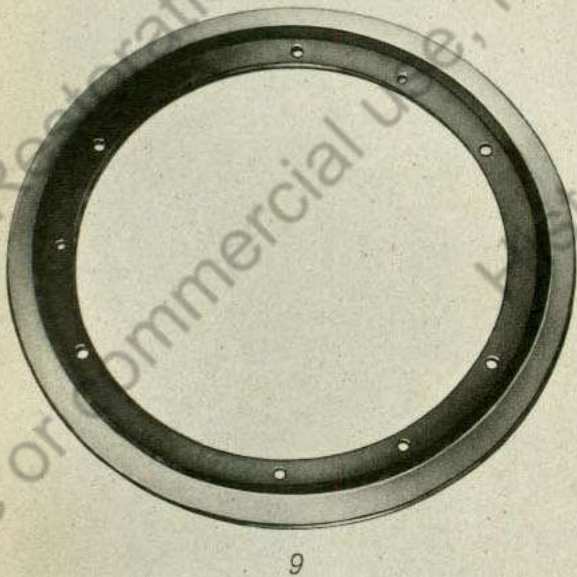
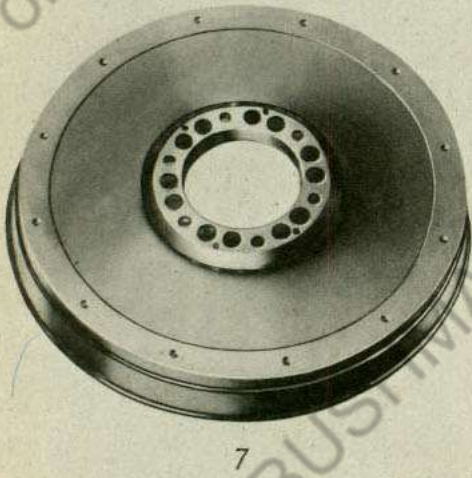
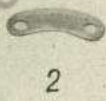
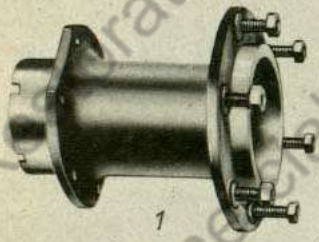

Gruppe: Laufwerk

TAFEL 12

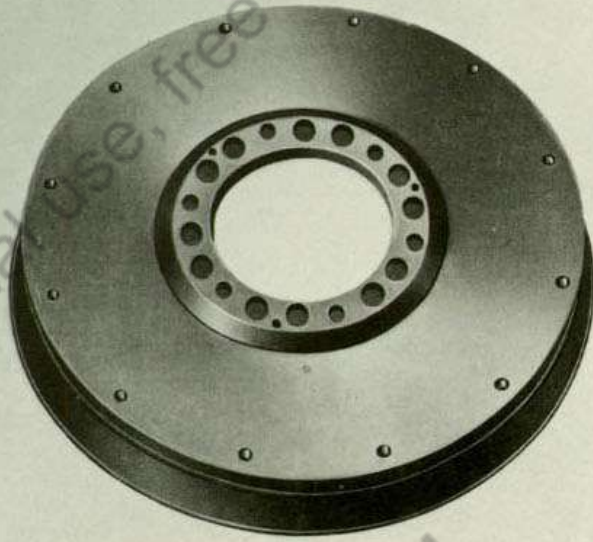

1



2



3



4



5



6

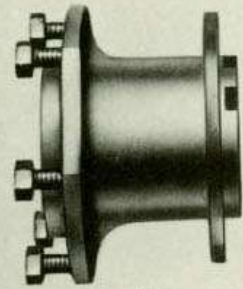

7



8

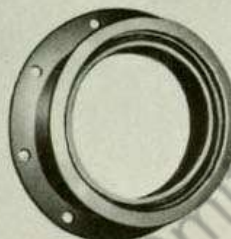

9

Gruppe: Laufwerk

TAFEL 13

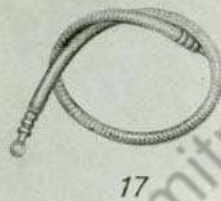
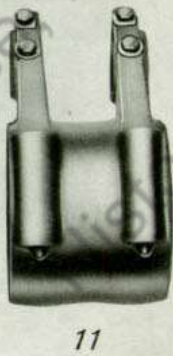
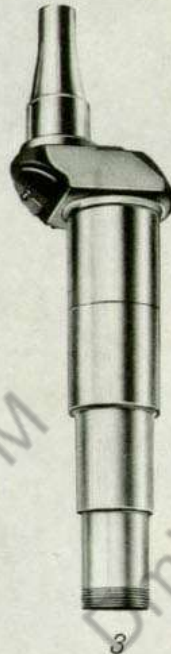
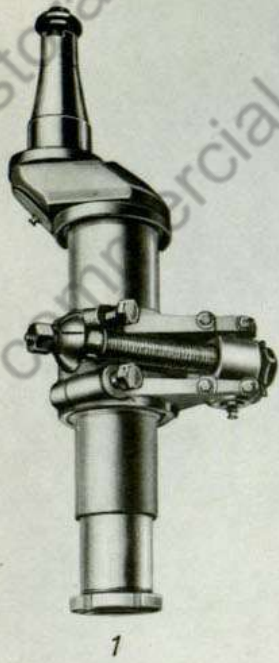

Gruppe: Kettennachstellung

TAFEL 14

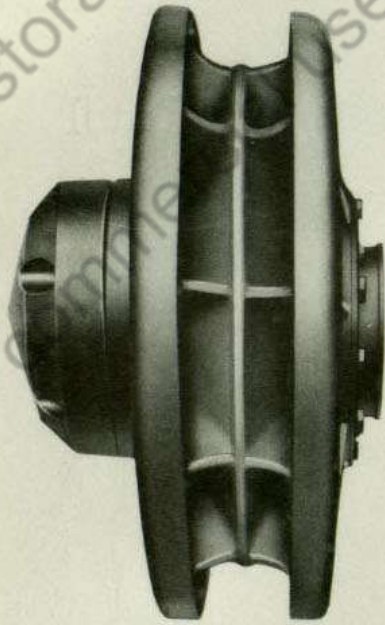

1

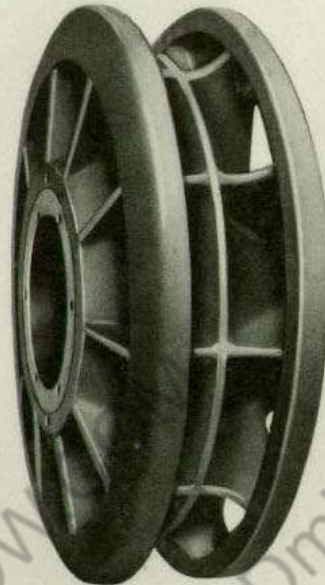

2

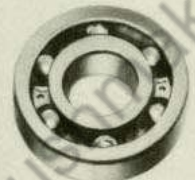

3



4



5



6



7



8



9



10

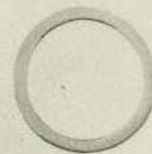

11

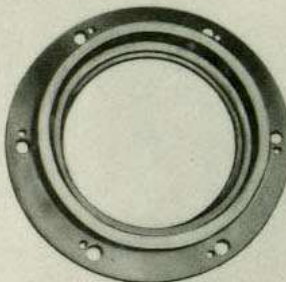

12



13



14

Gruppe: Leitrad

TAFEL 15

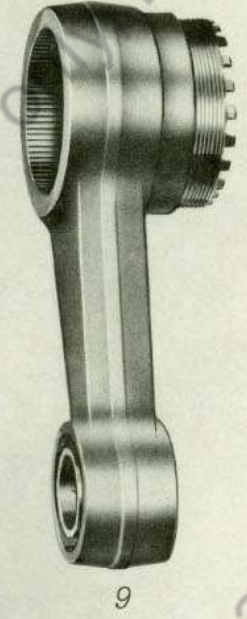
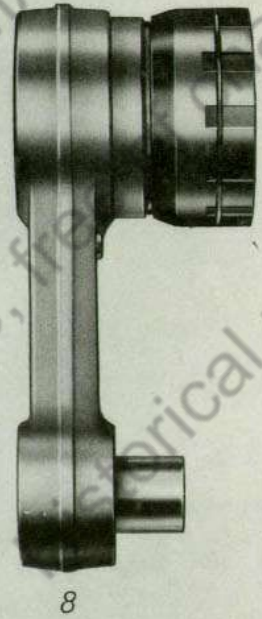
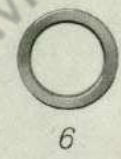
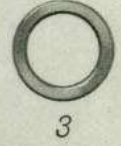
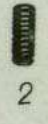

Gruppe: Stoßdämpfer

TAFEL 16

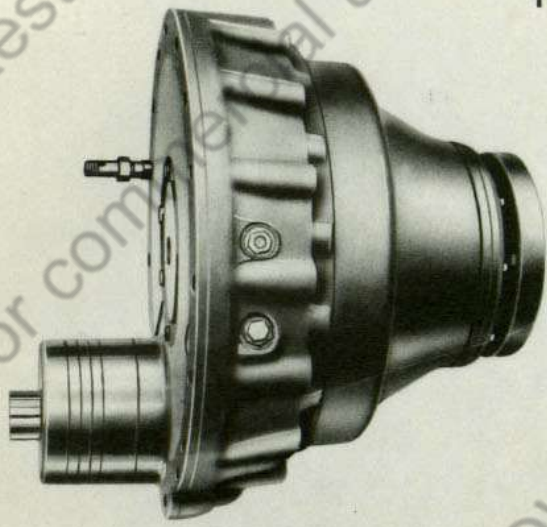

1

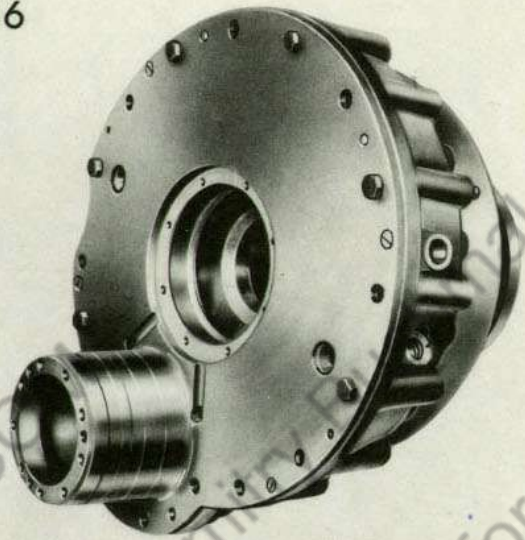

2



3



4



5



6

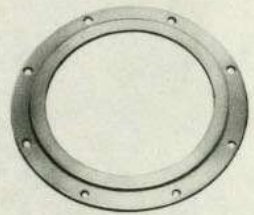

7



8



9



10



11

Gruppe: Kettenantrieb

TAFEL 17

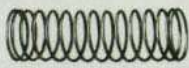
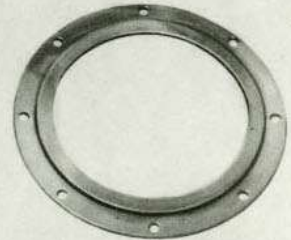
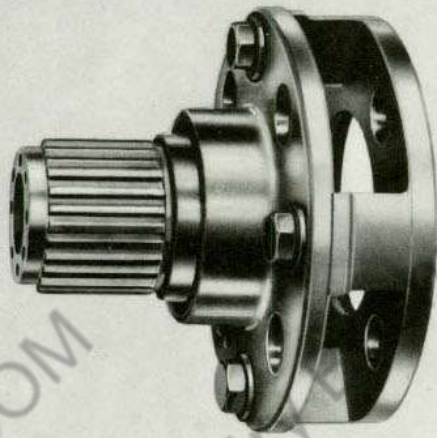
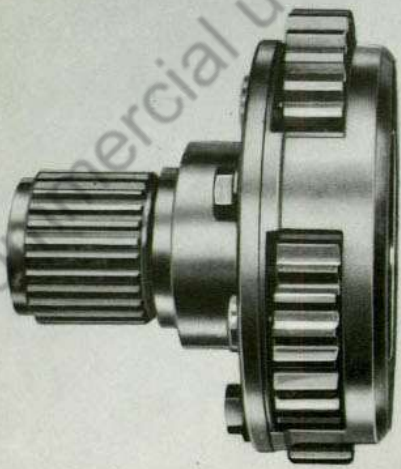

Gruppe: Kettenantrieb

TAFEL 18

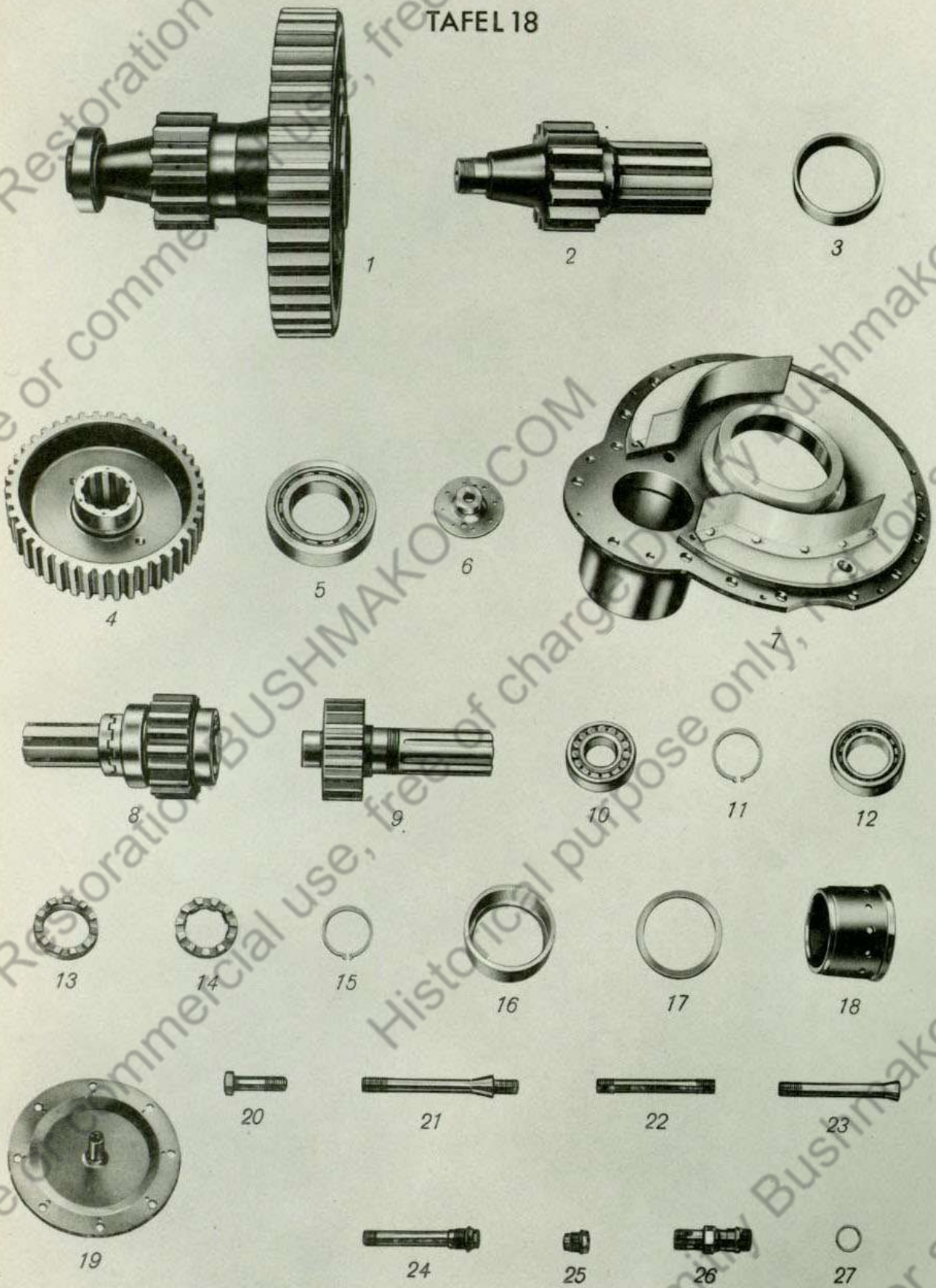

Gruppe: Kettenantrieb

TAFEL 19

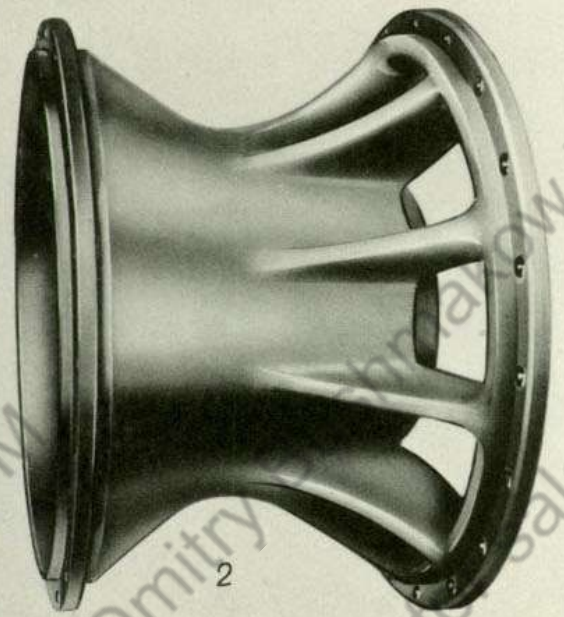
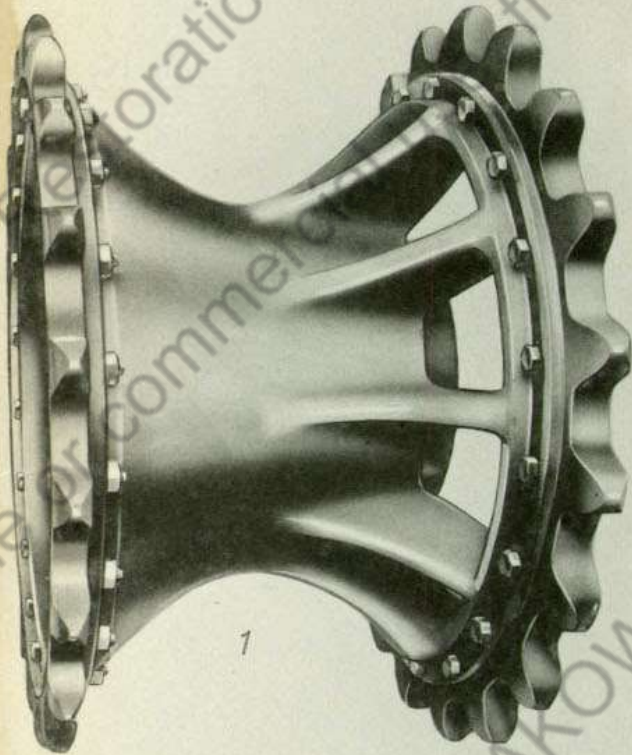

Gruppe: Treibrad

TAFEL 20

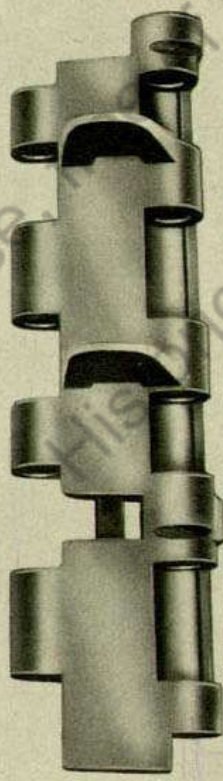
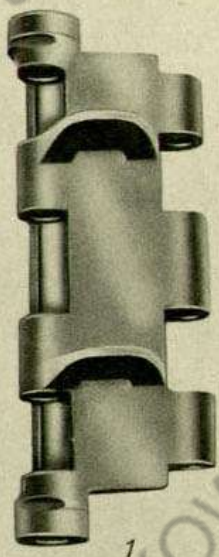

TAFEL 21

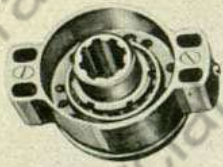

2



3

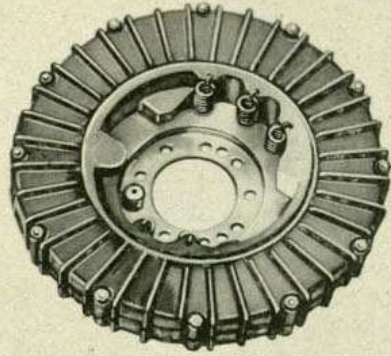

4

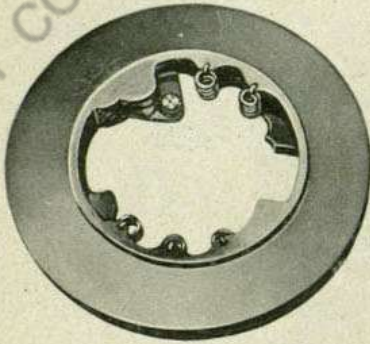

5

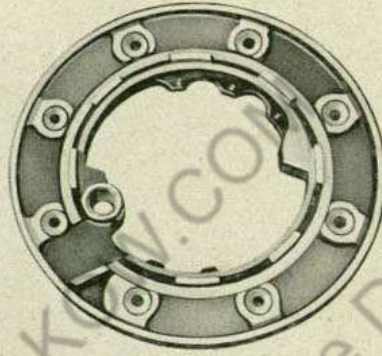

6

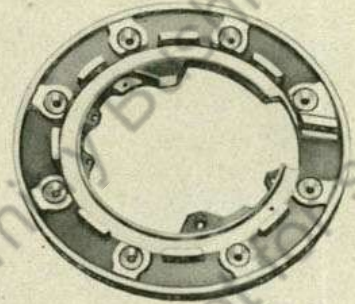

7



8



9



10



11



12



13

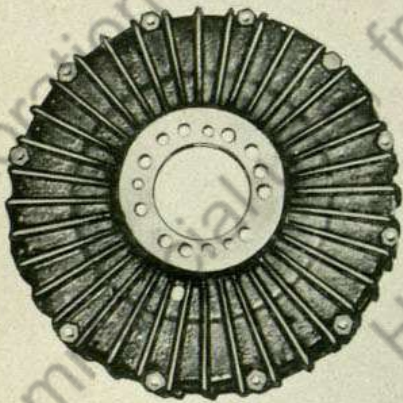

14



15

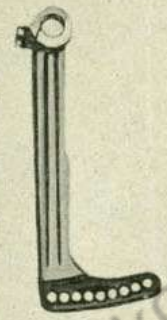

16



17

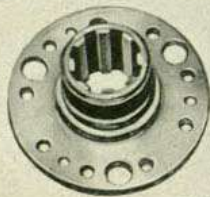

18



19



20



21



22



23

Gruppe: Kettenbremse

TAFEL 22

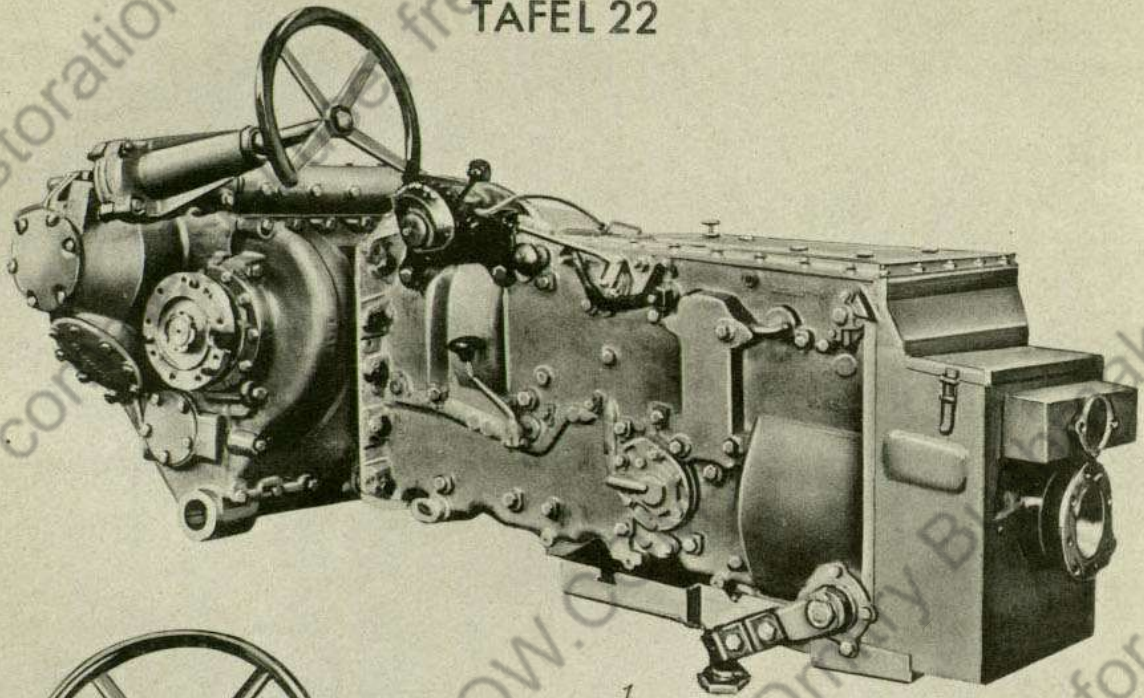

1

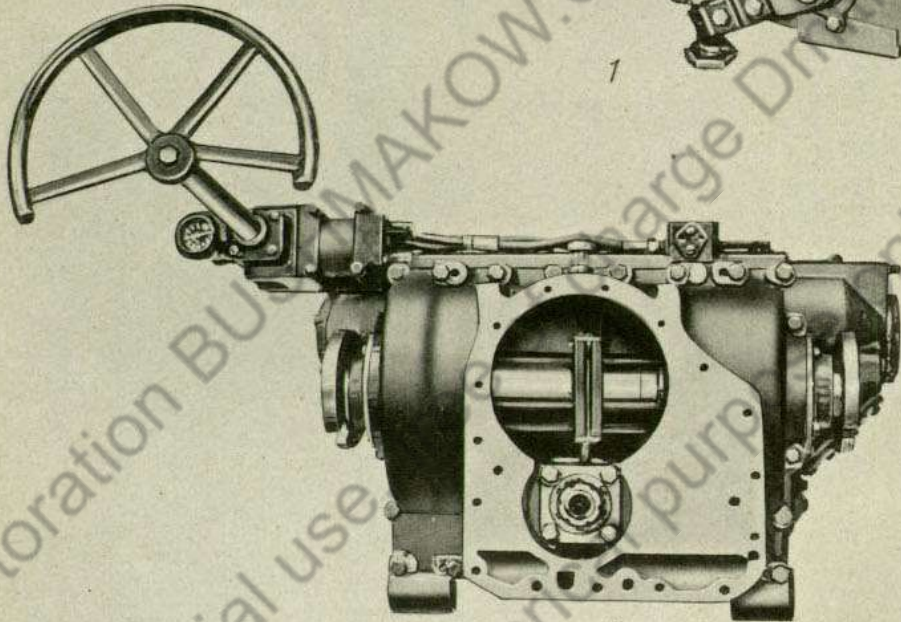

2

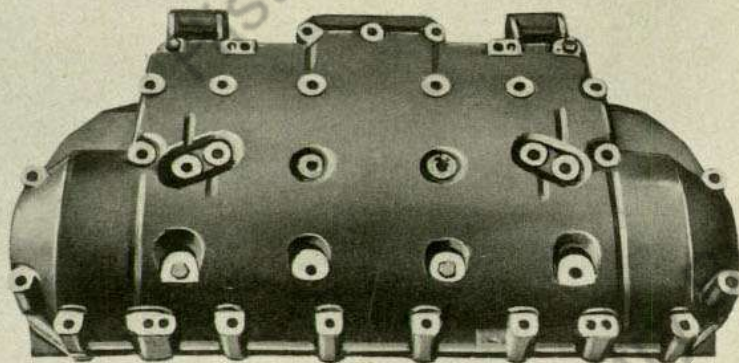

3

Gruppe: Lenkgetriebe

TAFEL 23

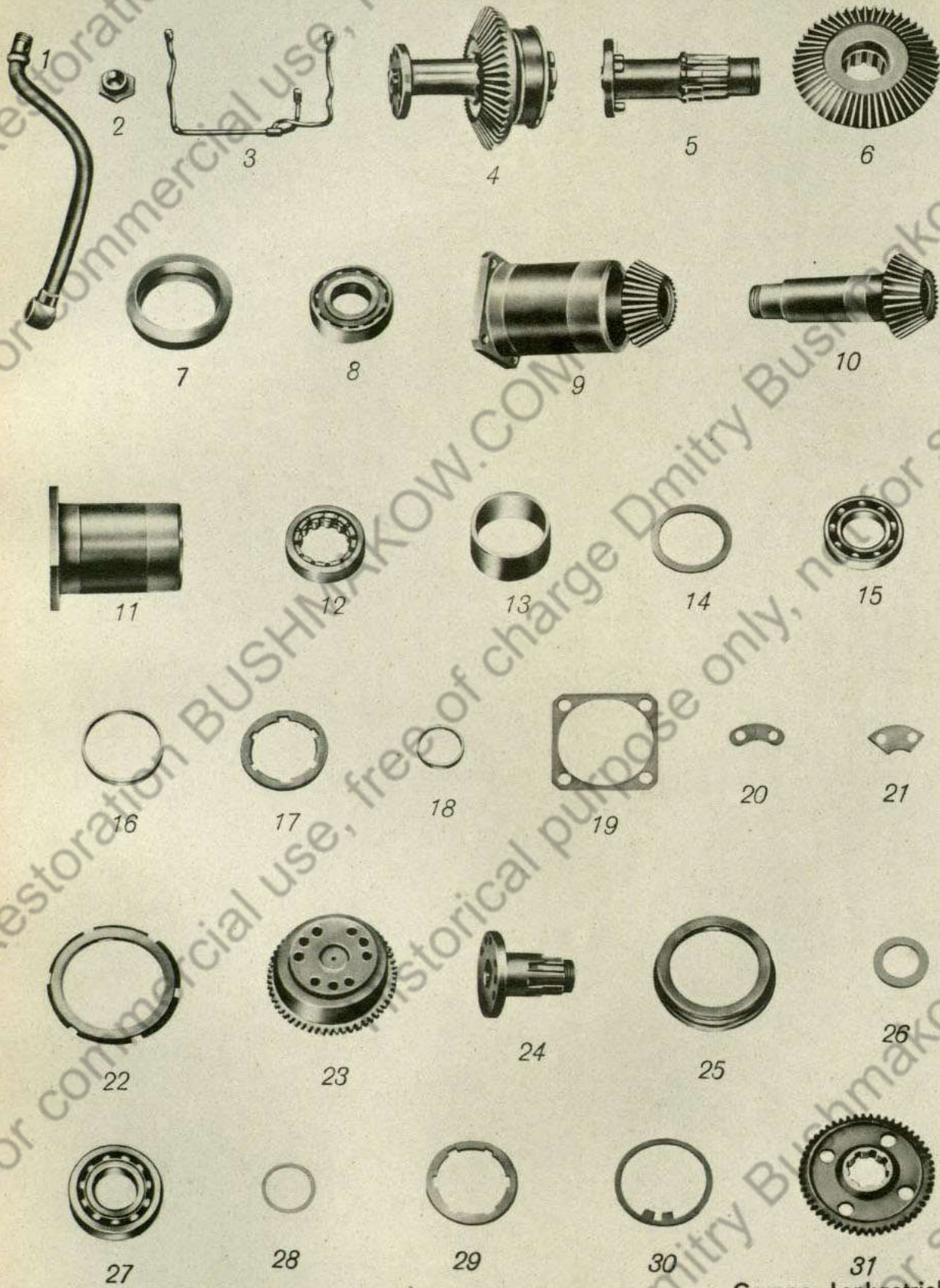

Gruppe: Lenkgetriebe

TAFEL 24

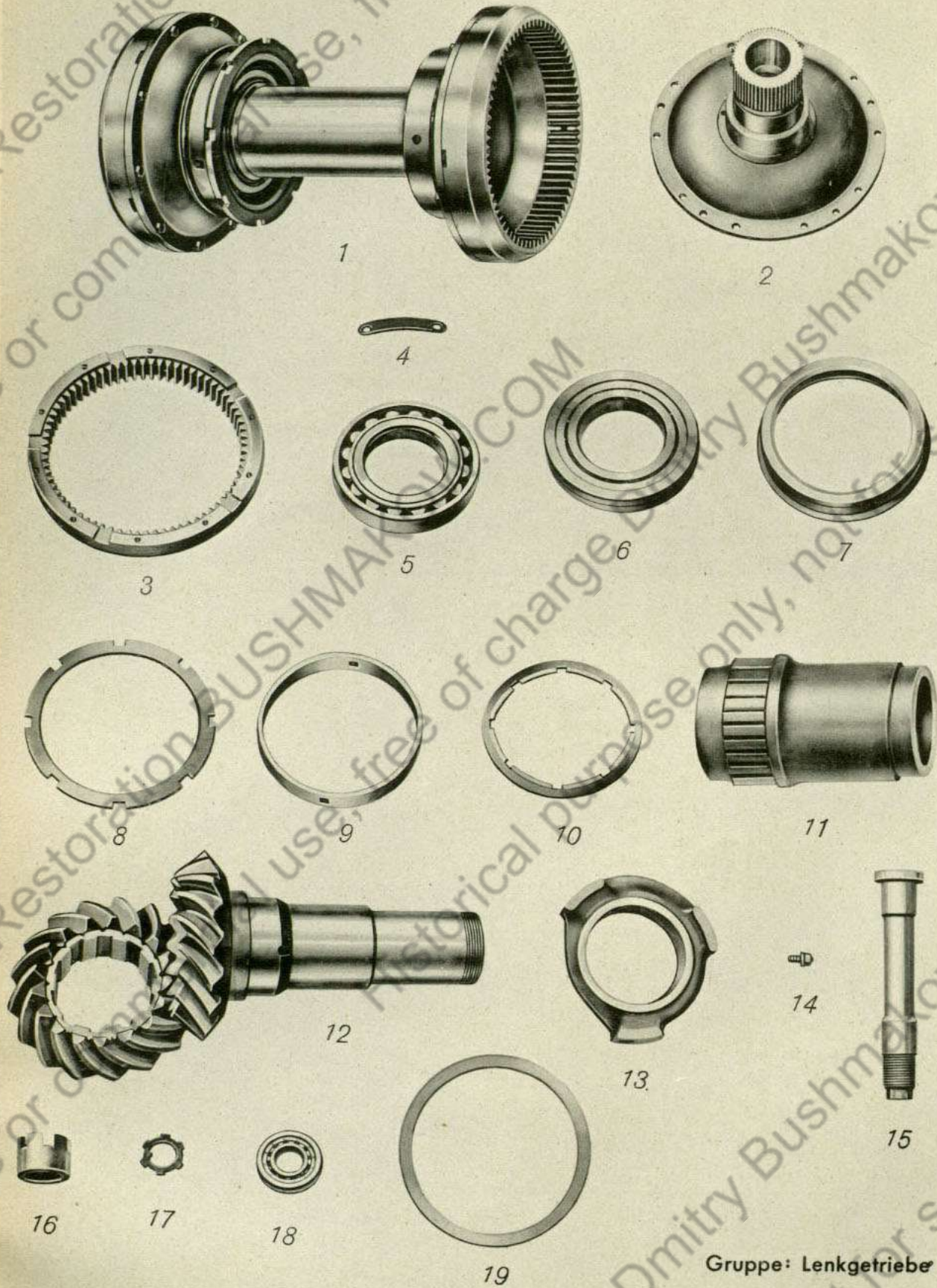

Gruppe: Lenkgetriebe

TAFEL 25

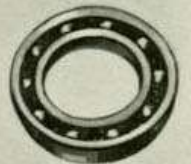
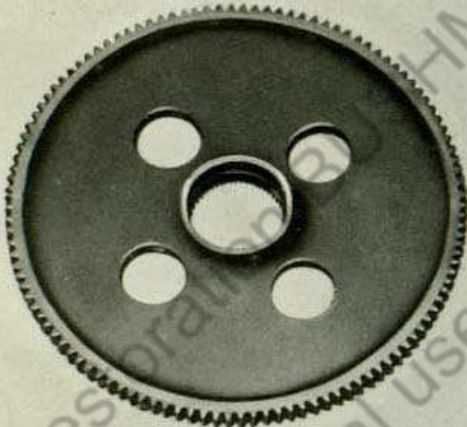
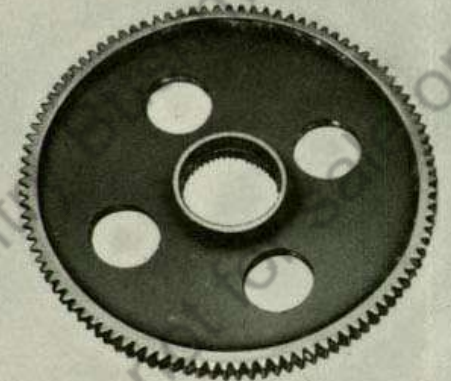
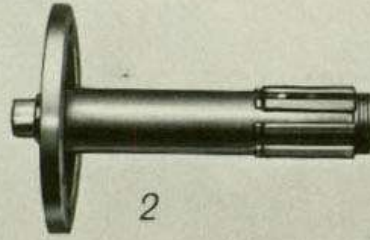
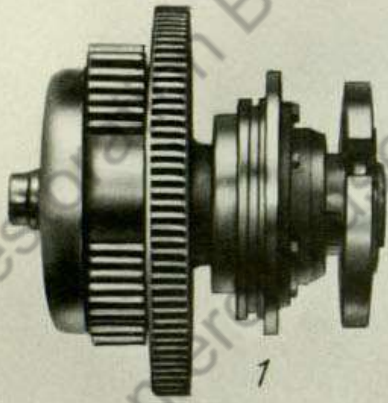

10

11

12

13

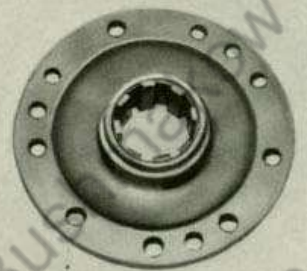

14

15

16

17



18

19

20

Gruppe: Lenkgetriebe

TAFEL 26

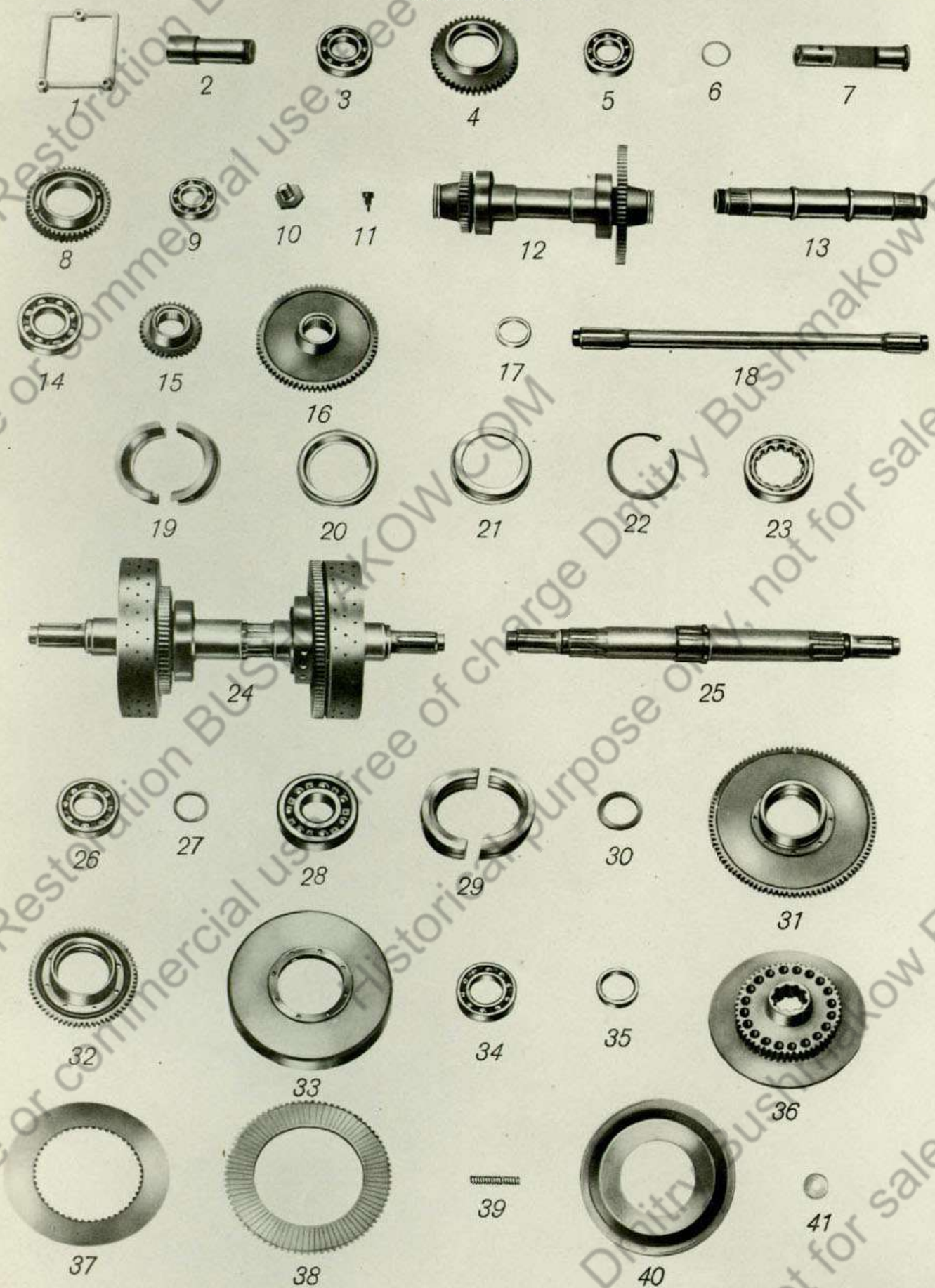

Gruppe: Lenkgetriebe

TAFEL 27

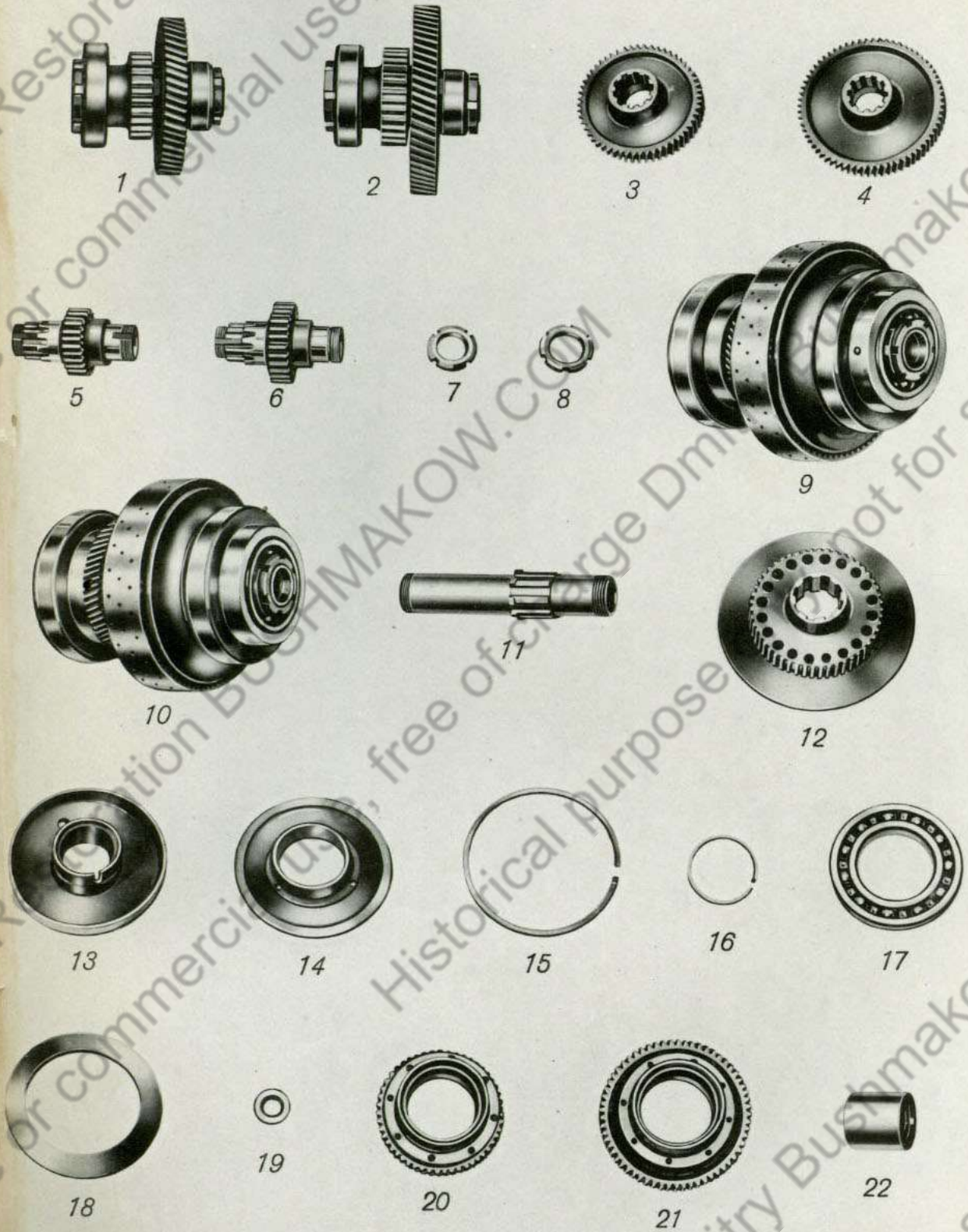

Gruppe: Lenkgetriebe

TAFEL 28

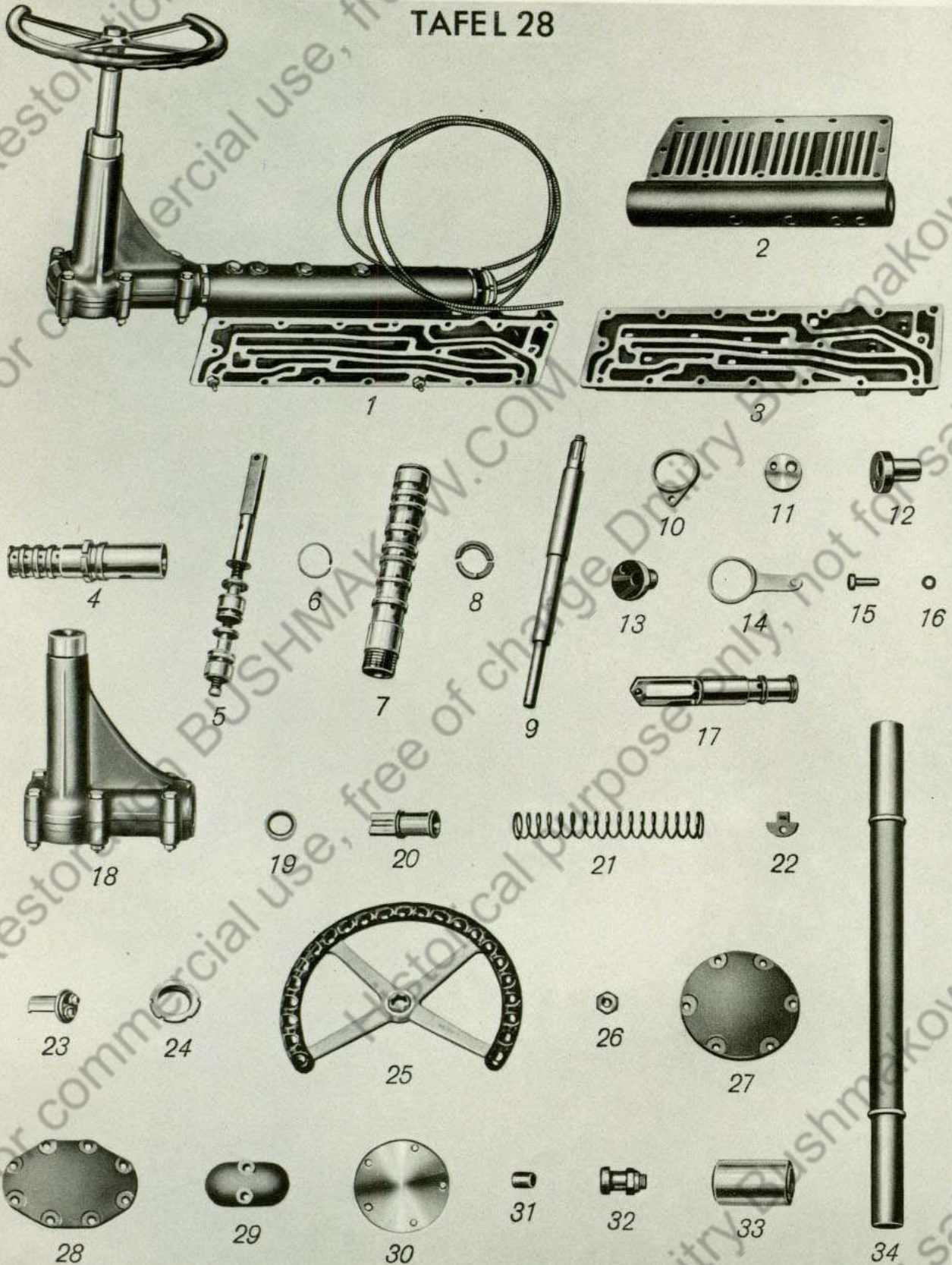

Gruppe: Lenkgetriebe

TAFEL 28 a

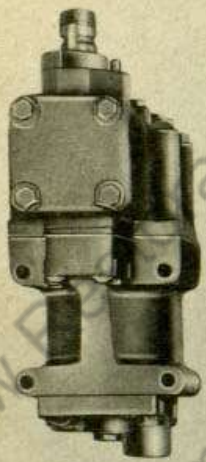

1

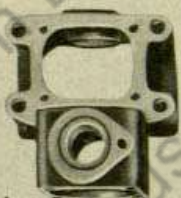

2



3



4



5



6



7



8



9



10



11



12



13

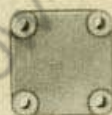

14



15

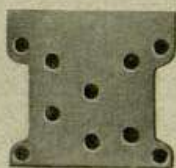

16



17



18



19



20



21



22



23



24



25



26



27



28



29



30



31



32



33



34

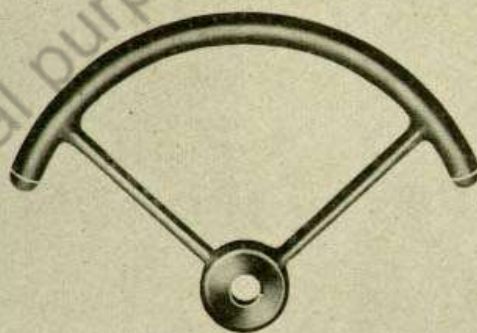

35



36



37

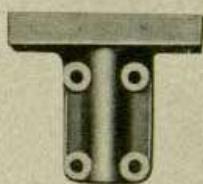

38



39



40

41



42



43



44



45



46



47

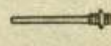

48

Gruppe: Lenkgetriebe

TAFEL 29

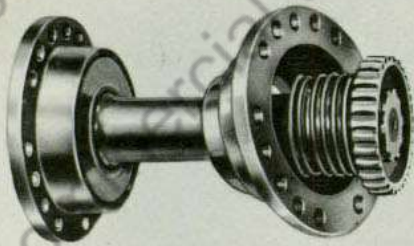

1

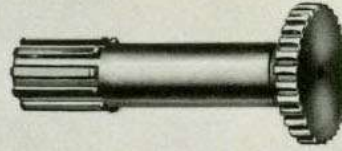

2

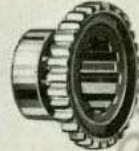

3



4



5



6



7

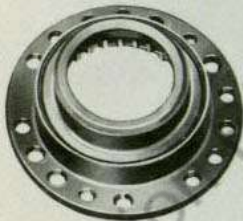

8



9



10



11



12



13

Gruppe: Lenkgetriebewelle (Bild 1-12)

Gruppe: Gelenkwelle (Bild 13)

TAFEL 30

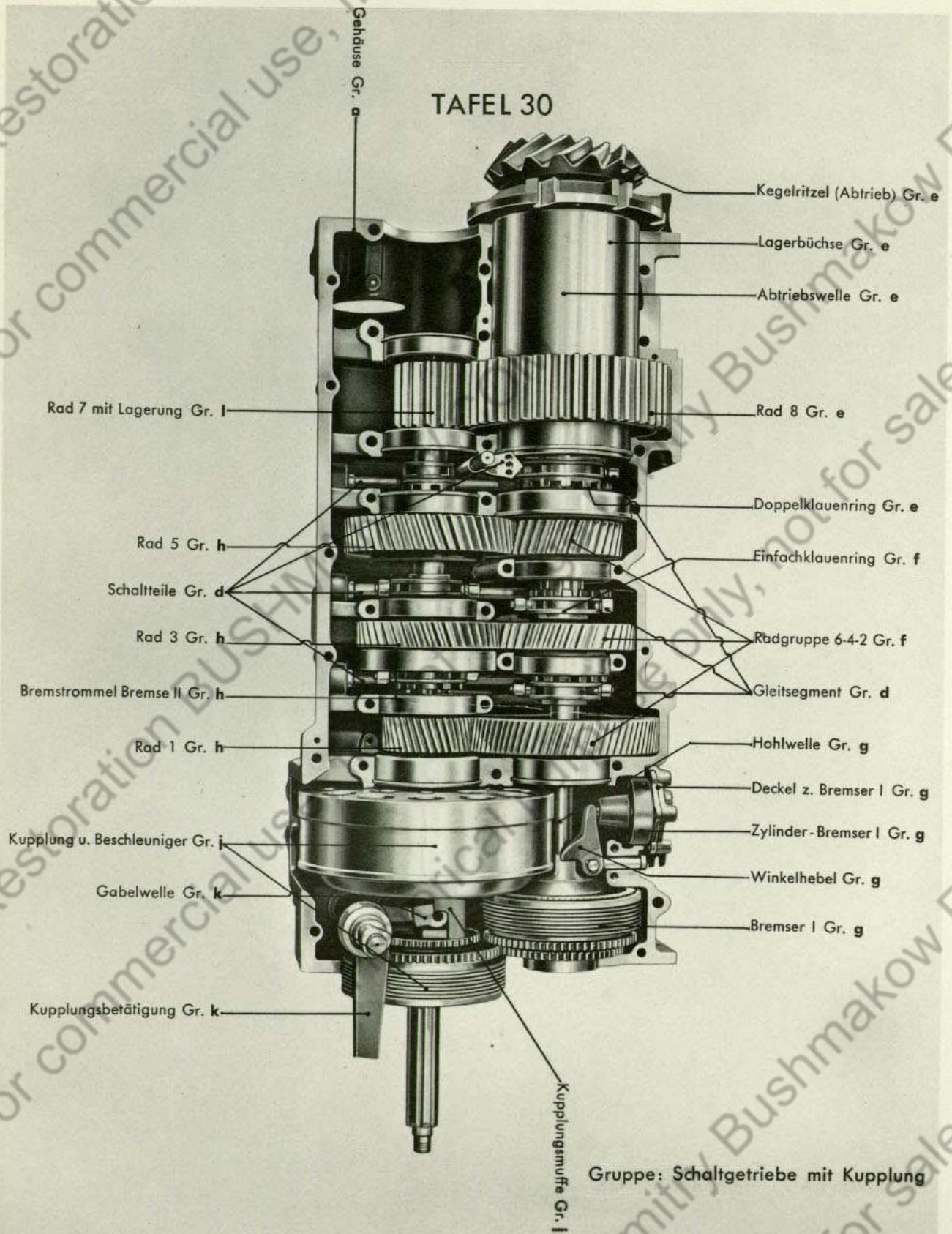

TAFEL 30 a

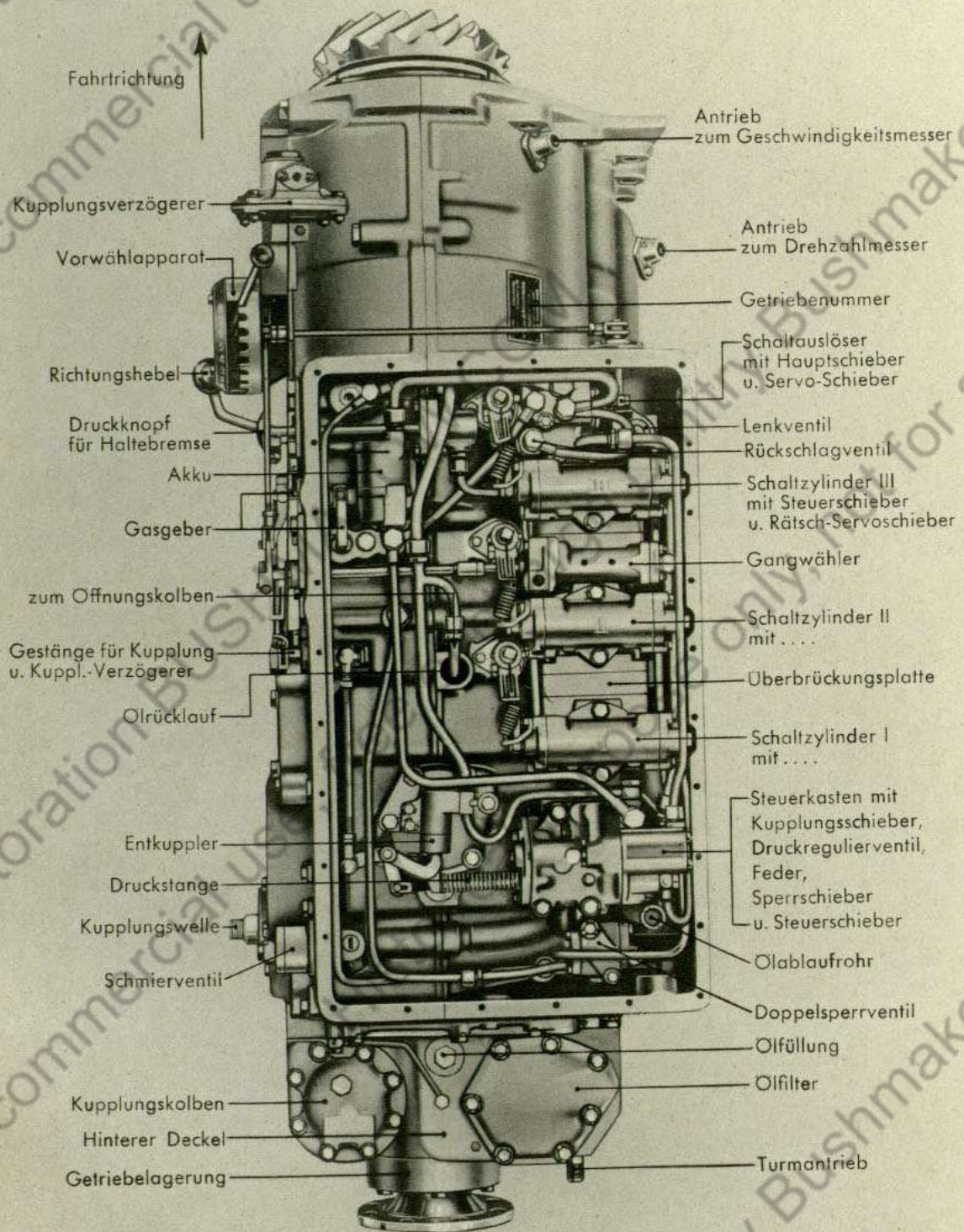

Gruppe: Schaltgetriebe mit Kupplung (Schnittbild)

TAFEL 31

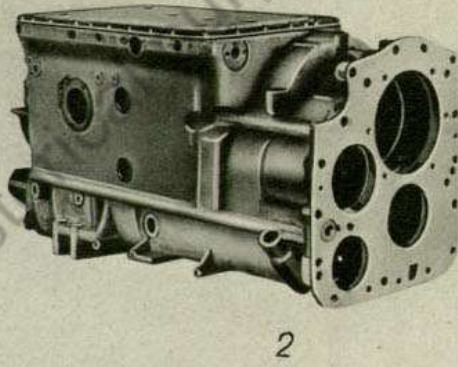
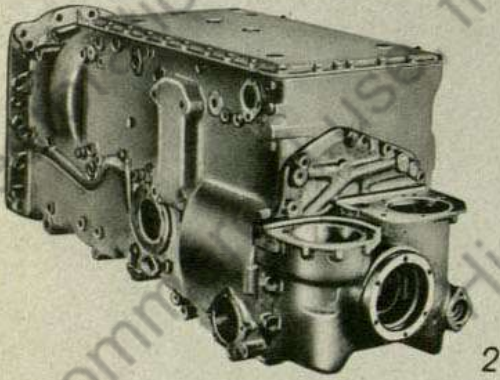
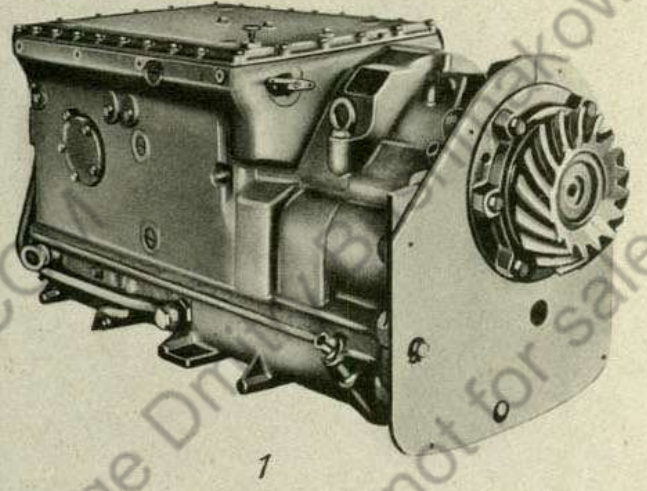
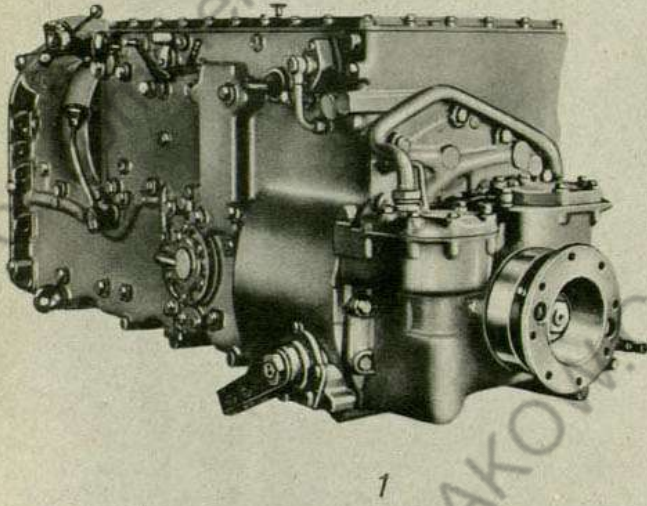

Gruppe: Schaltgetriebe mit Kupplung

TAFEL 32

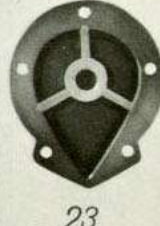
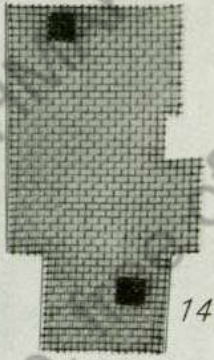
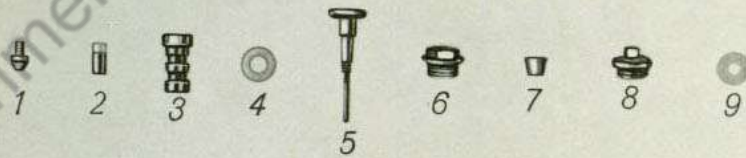
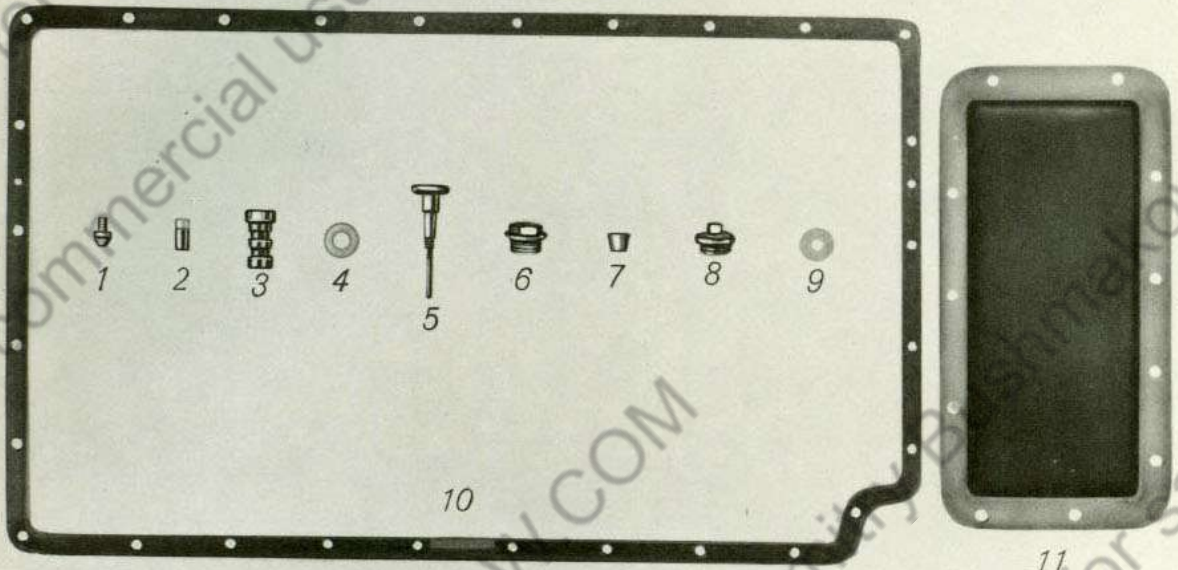

Gruppe: Schaltgetriebe mit Kupplung

TAFEL 33

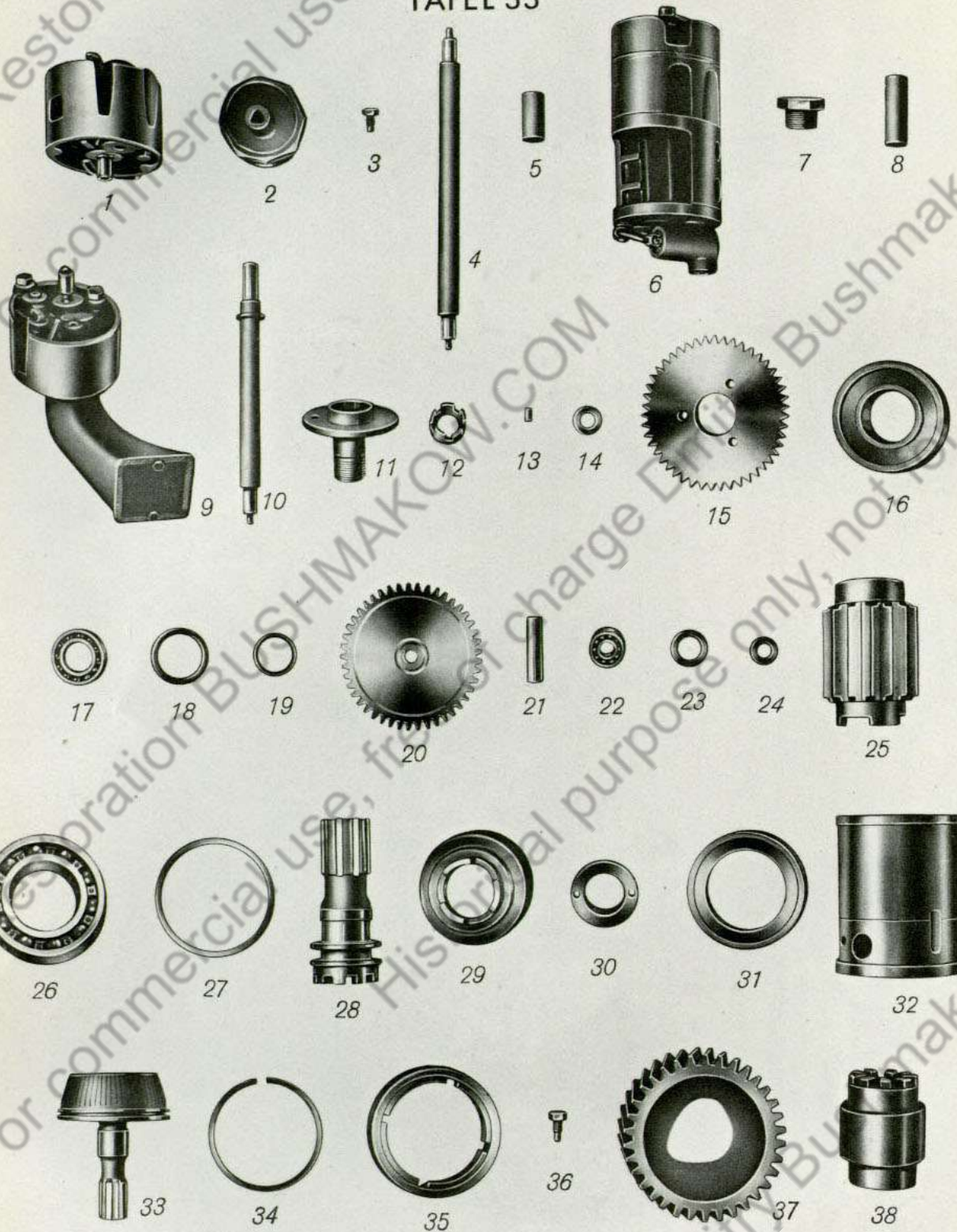

Gruppe: Schaltgetriebe mit Kupplung

TAFEL 33 a

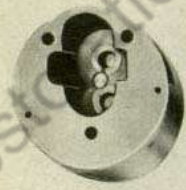

1



2



3



4



5

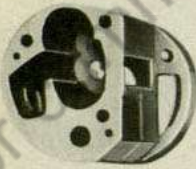

6

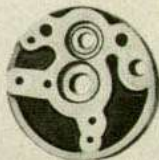

7



8



9



10



11



12



13



14



15



16

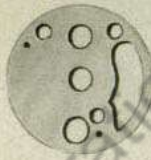

17



18



19

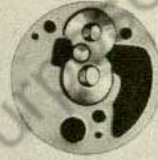

20



21



22



23



24



25



26



27



28

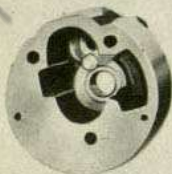

29



30



31



32



33



34

Gruppe: Schaltgetriebe mit Kupplung

TAFEL 34

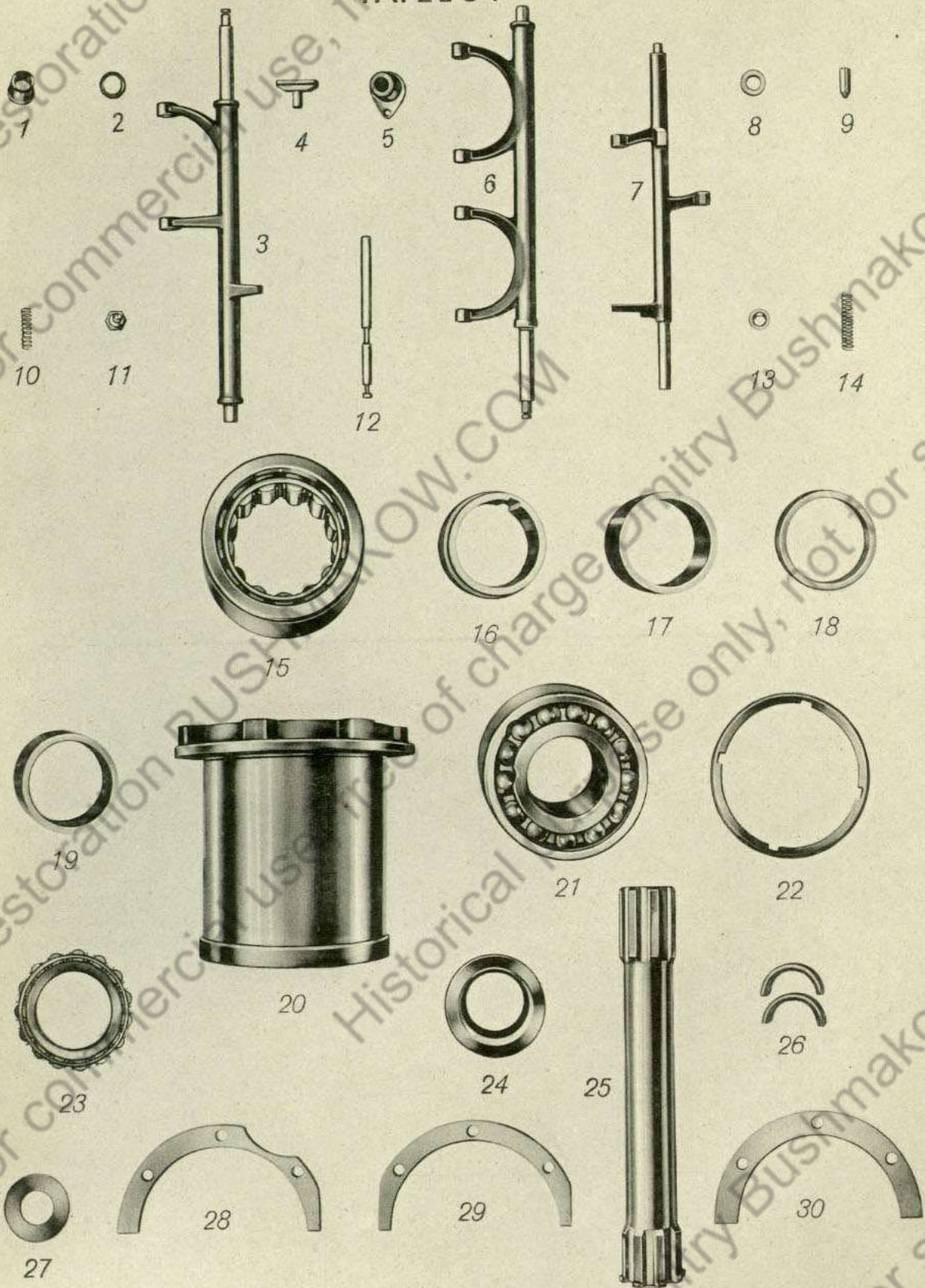

Gruppe: Schaltgetriebe mit Kupplung

TAFEL 34 a

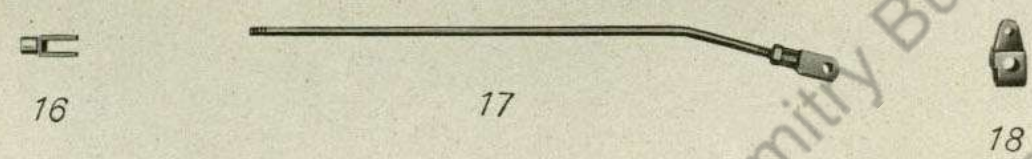
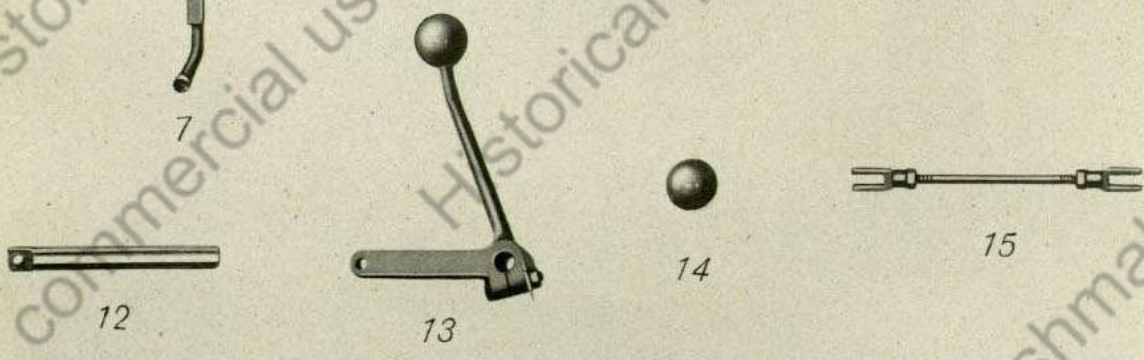
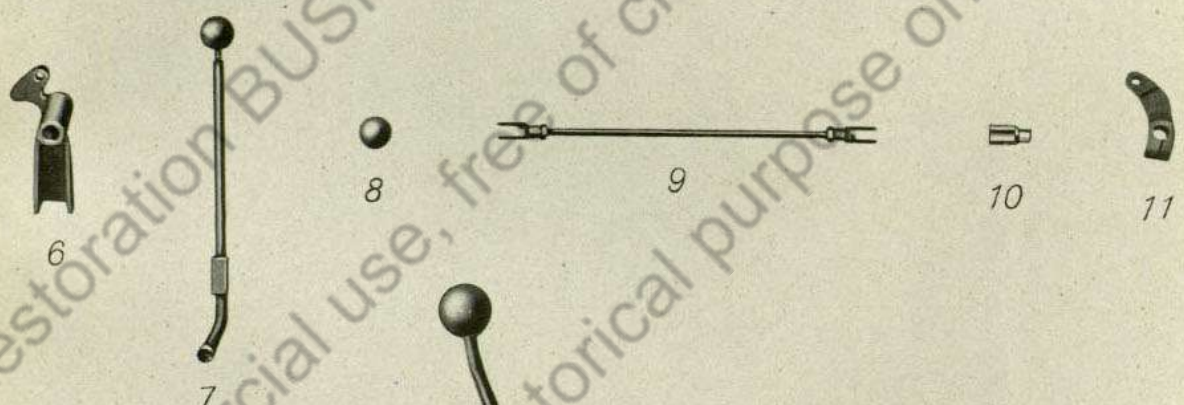
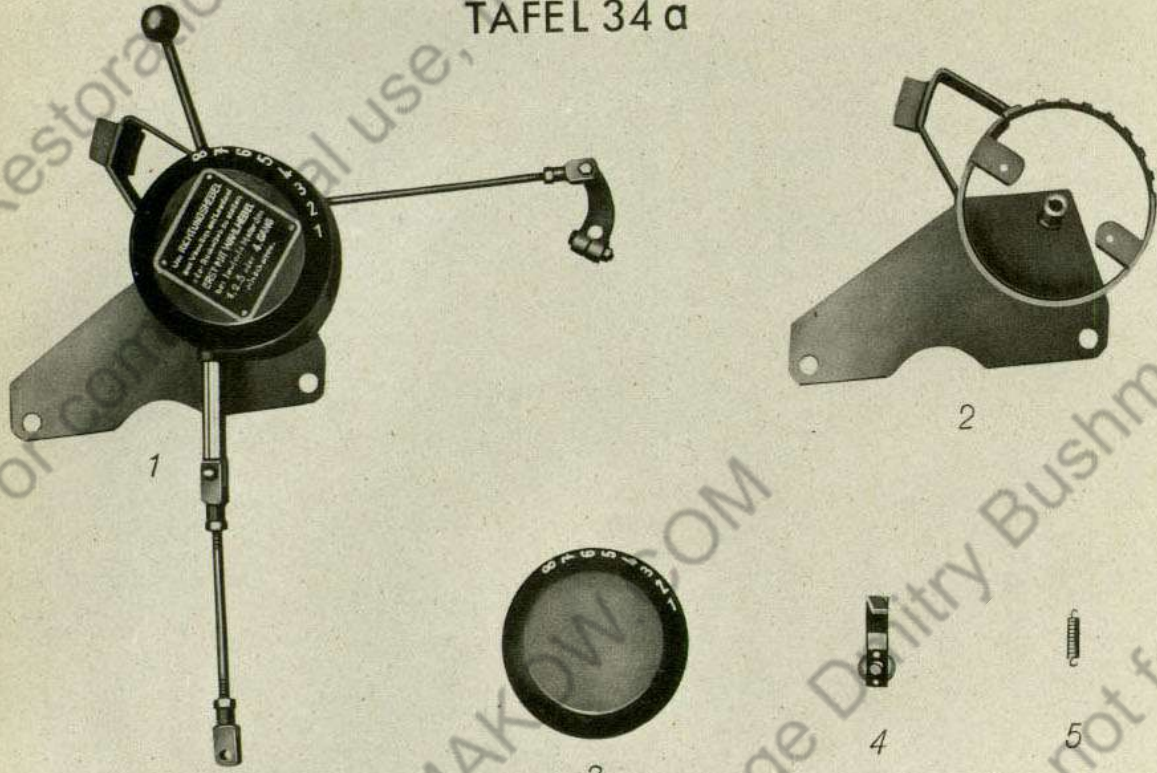

Gruppe: Schaltgetriebe mit Kupplung

TAFEL 35

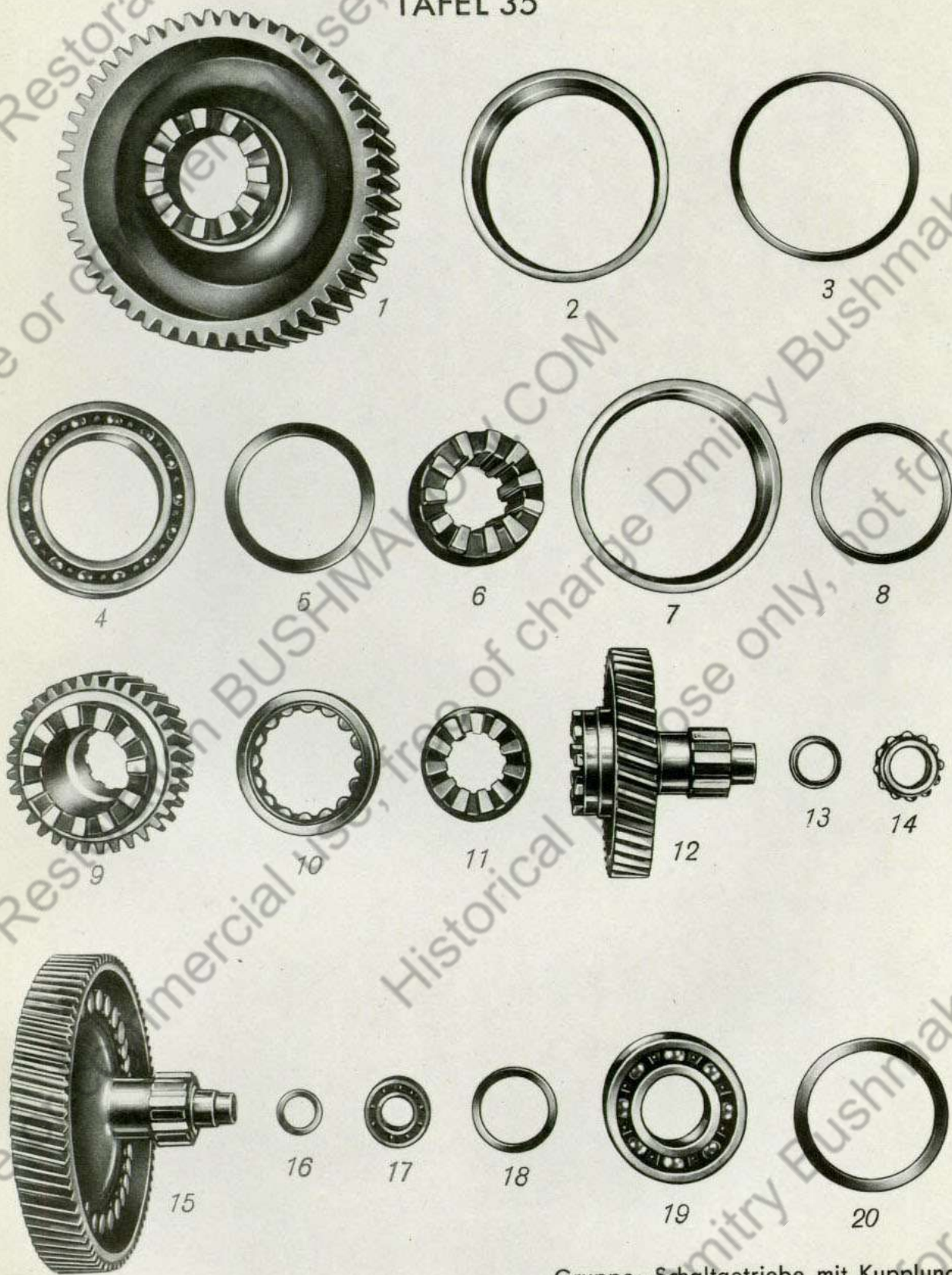

Gruppe: Schaltgetriebe mit Kupplung

TAFEL 36



1



2

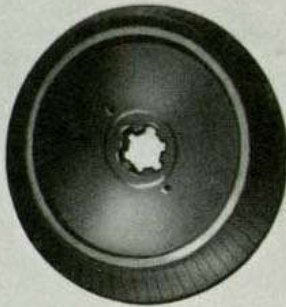

3



4

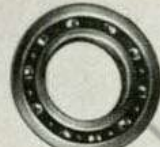

5



6

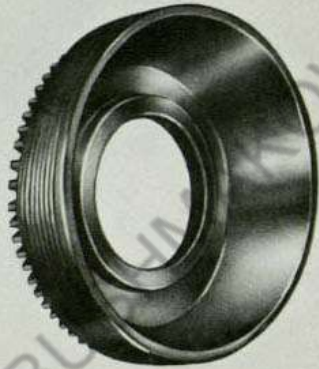

7



8



9



10



11



12



13



14

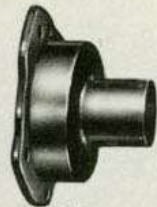

15



16



17



18



19



20



21



22

Gruppe: Schaltgetriebe mit Kupplung

TAFEL 37

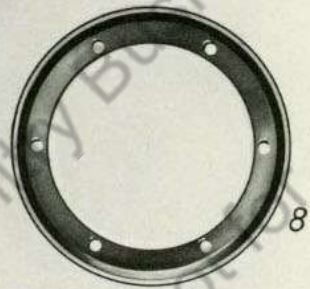
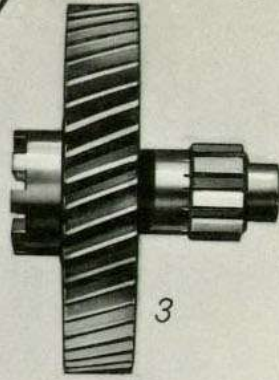

14

Gruppe: Schaltgetriebe mit Kupplung

TAFEL 38

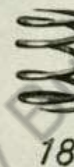
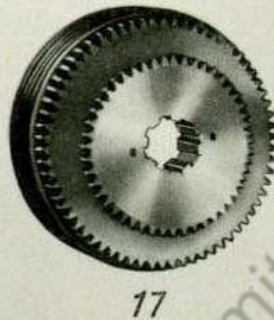
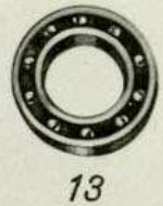
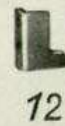
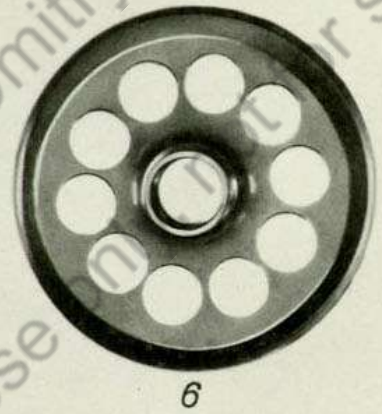
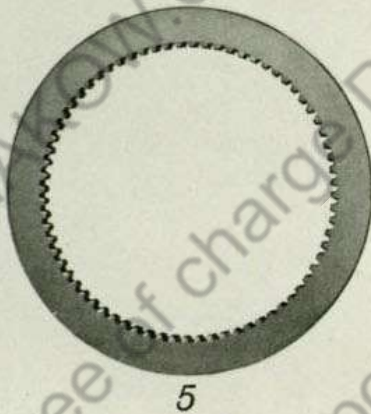
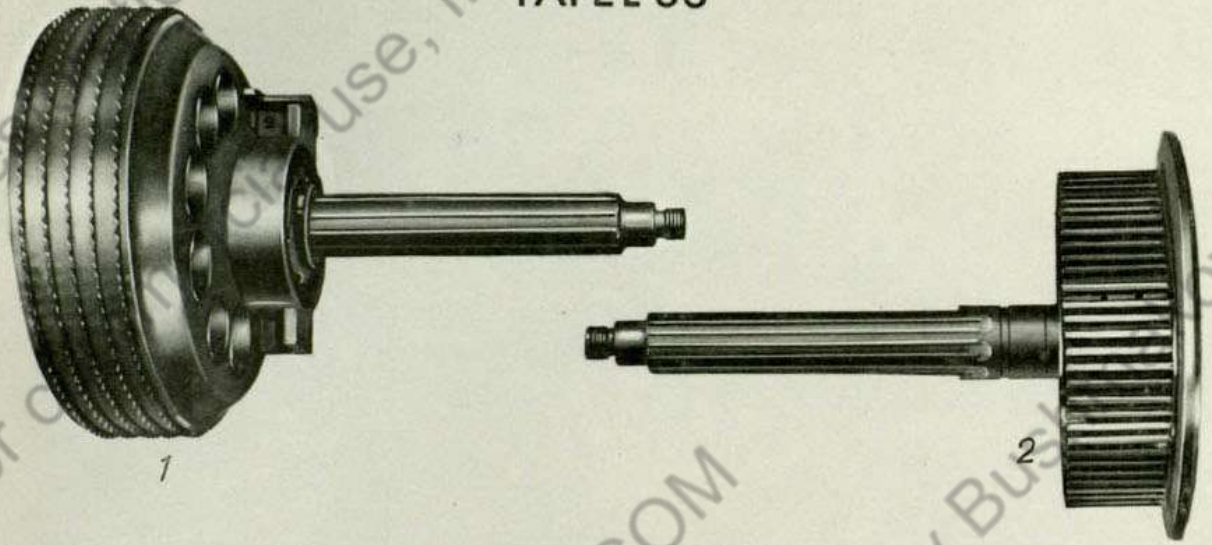

Gruppe: Schaltgetriebe mit Kupplung

TAFEL 39

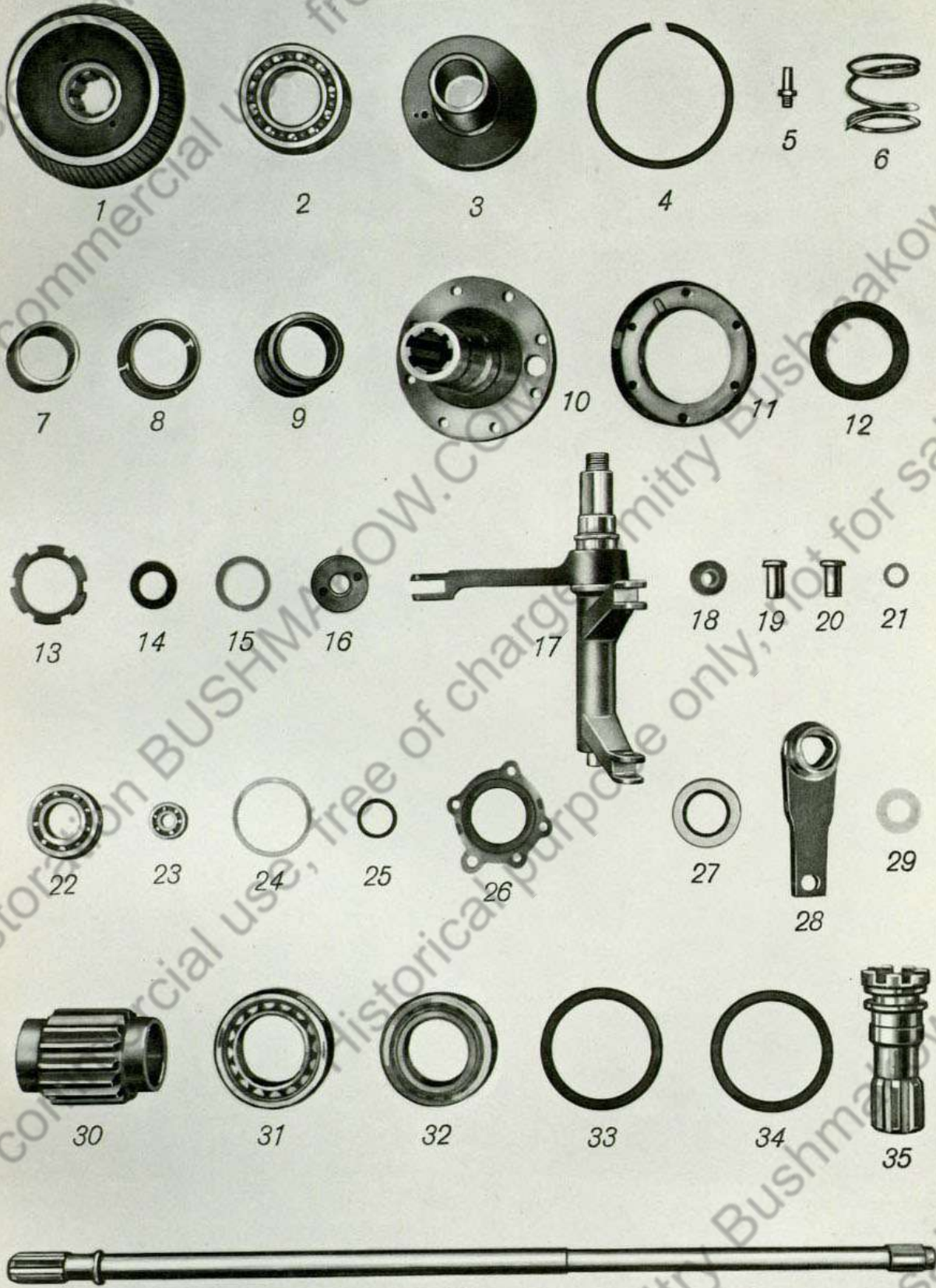

Gruppe: Schaltgetriebe mit Kupplung

TAFEL 40

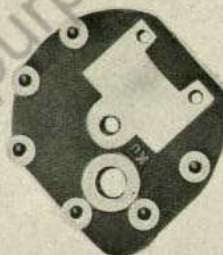
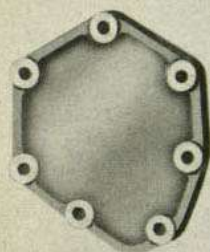
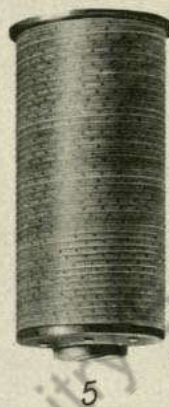
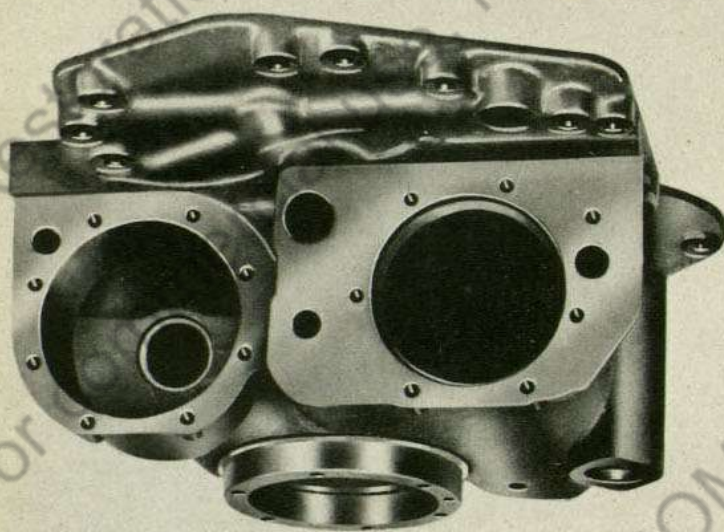

Gruppe: Schaltgetriebe mit Kupplung

TAFEL 41

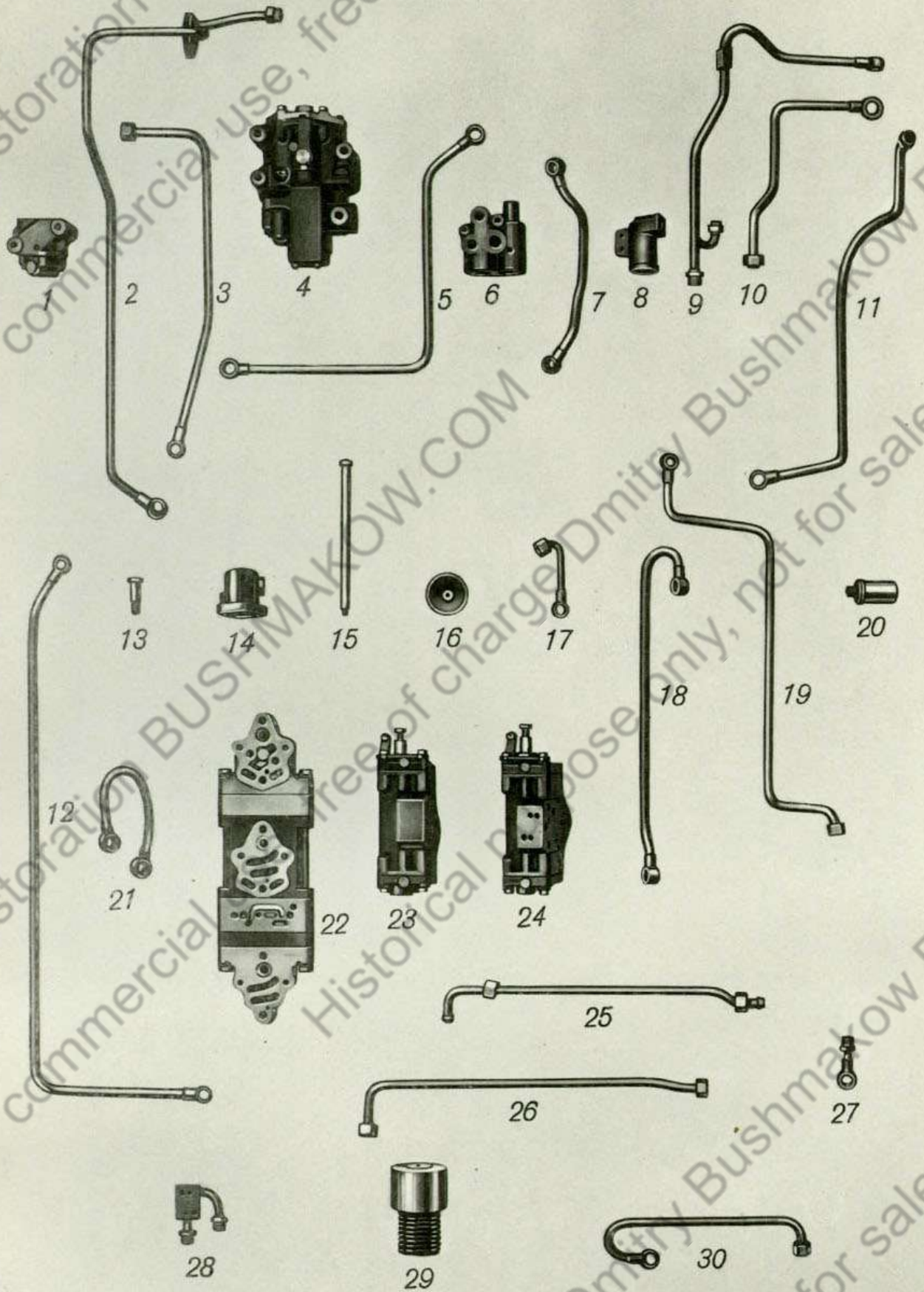

Gruppe: Schaltgetriebe mit Kupplung

TAFEL 41a

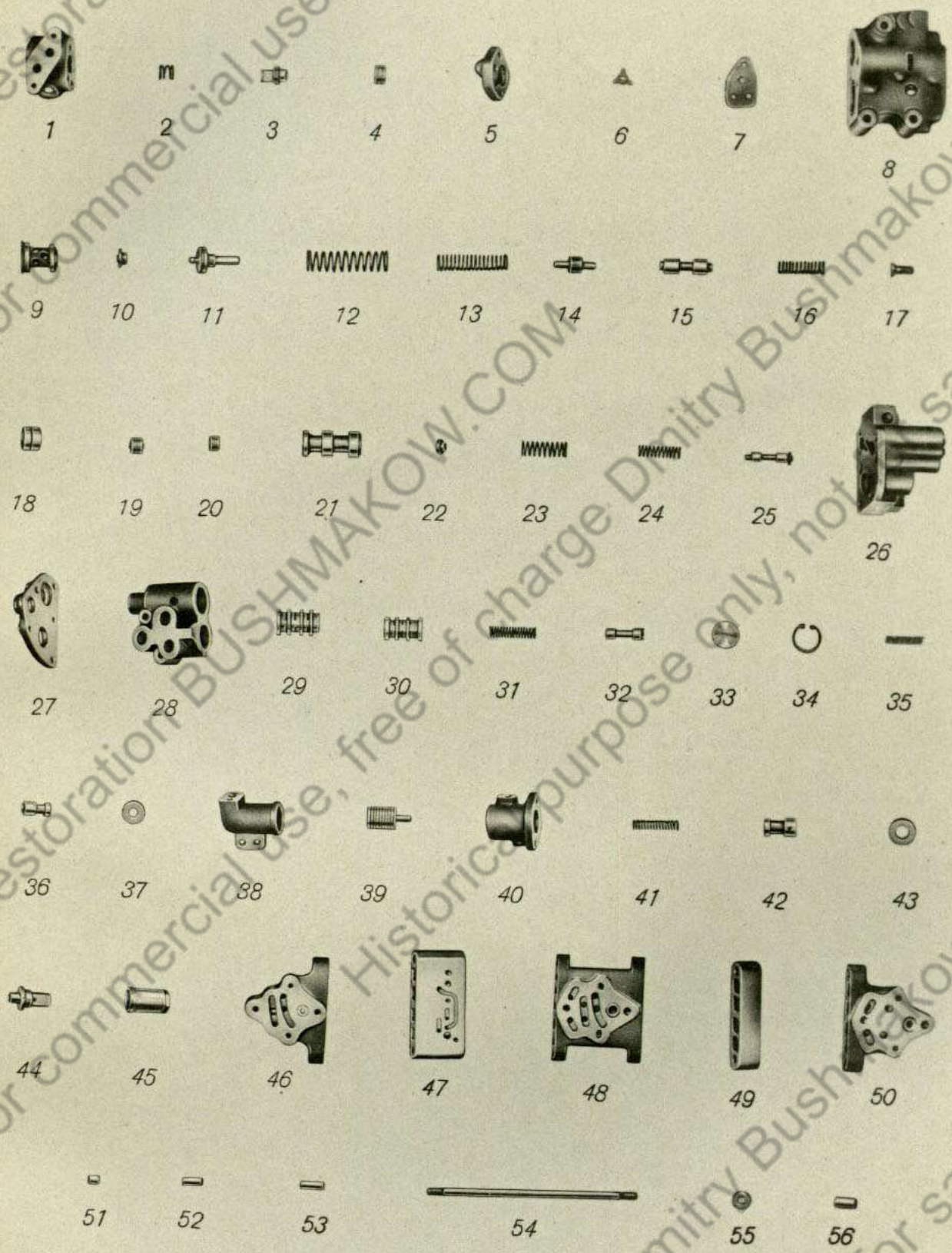

Gruppe: Schaltgetriebe mit Kupplung

TAFEL 42

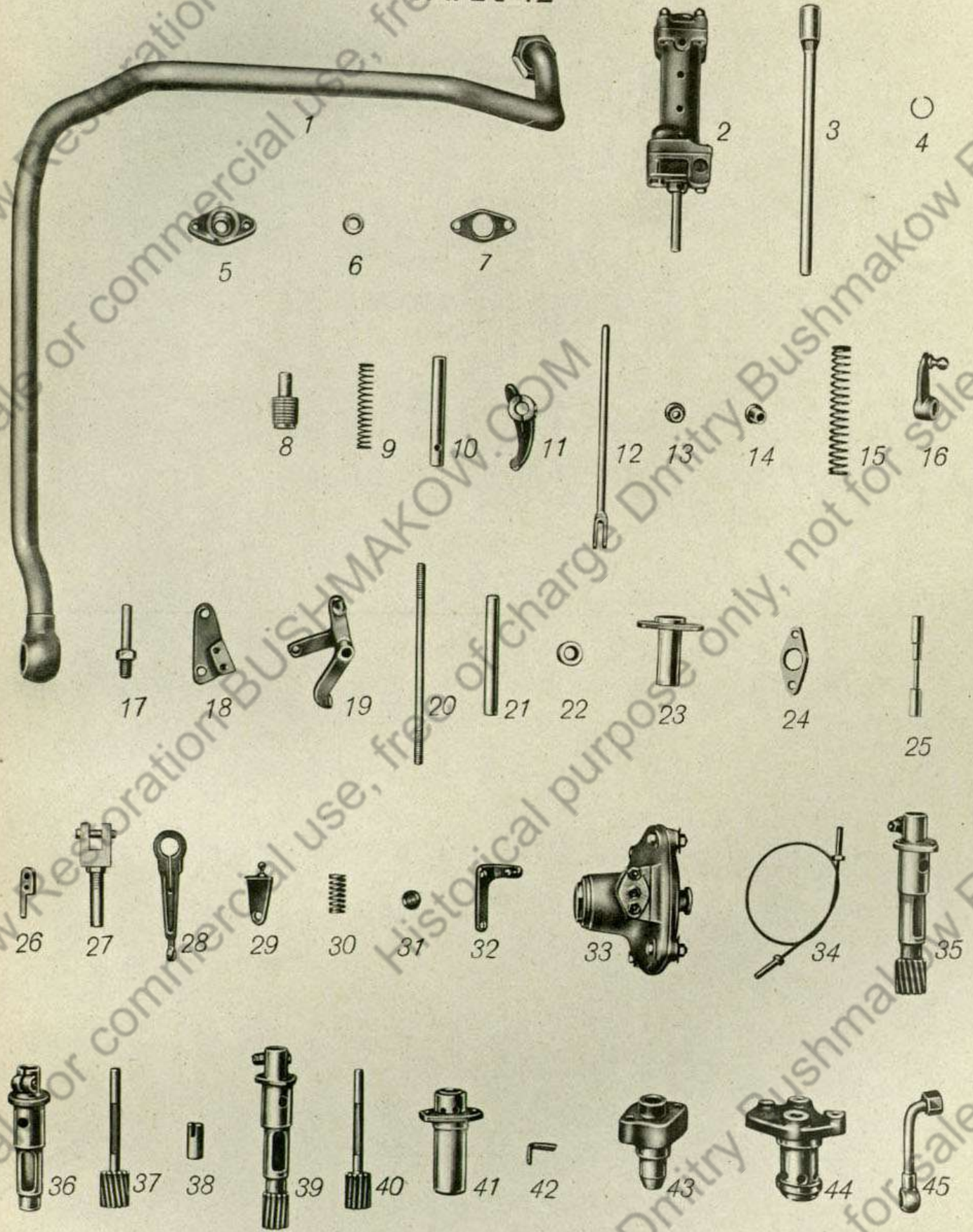

Gruppe: Schaltgetriebe mit Kupplung

TAFEL 42 a



1



2



3



4



5

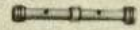

6



7



8



9



10

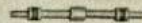

11



12



13



14



15



16



17



18



19



20



21



22



23



24



25



26



27



28



29



30



31



32



33



34



35

36

37



38



39



40



41



42

Gruppe: Schaltgetriebe mit Kupplung

TAFEL 43

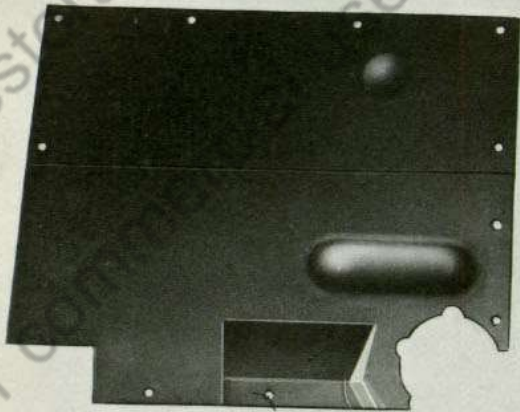

1

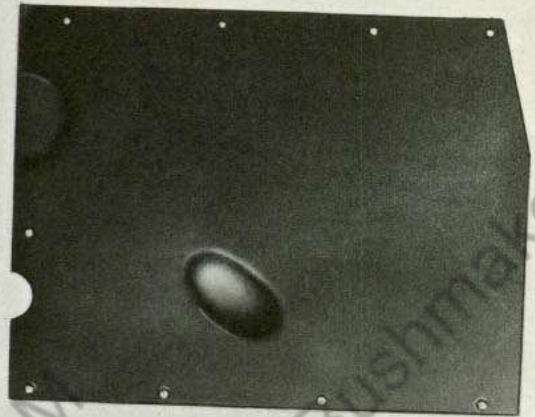

2

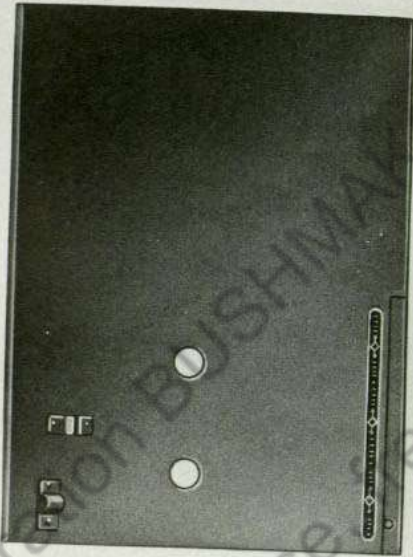

3

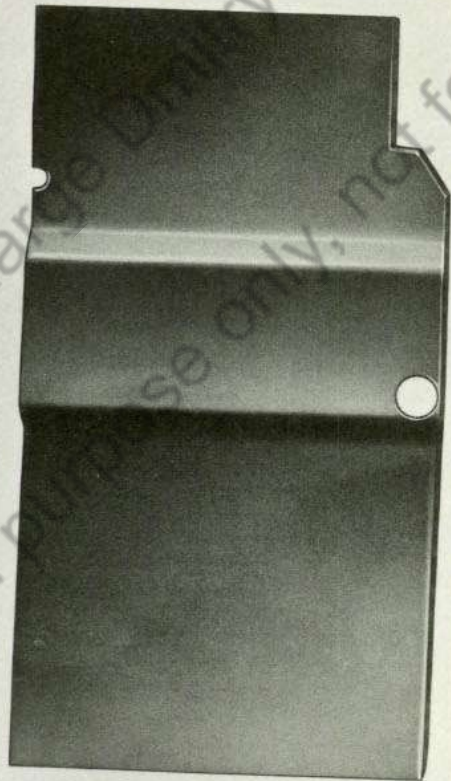

4

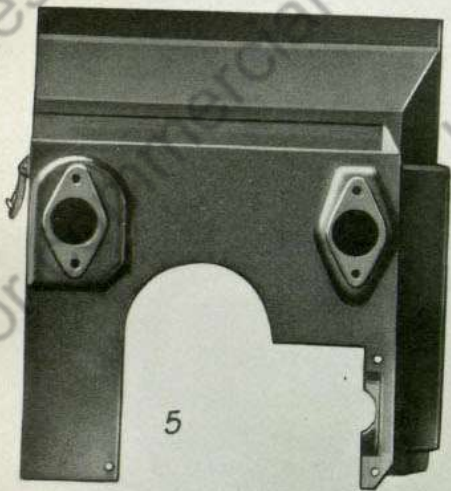

5

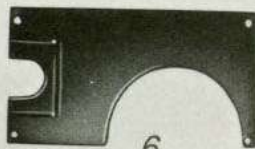

6



7



8

Gruppe: Schaltgetriebe mit Kupplung

TAFEL 44

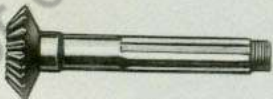
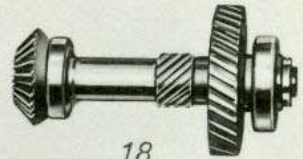
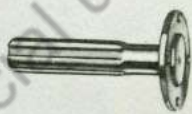
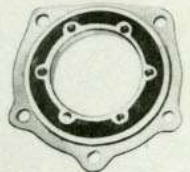
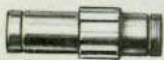
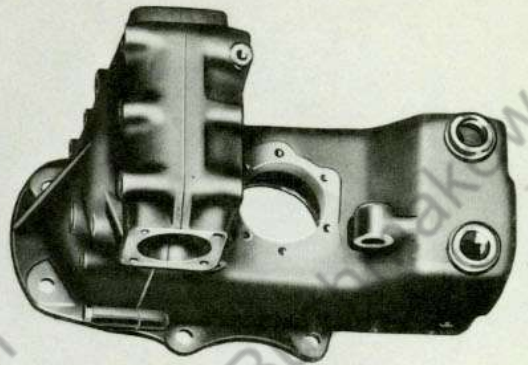
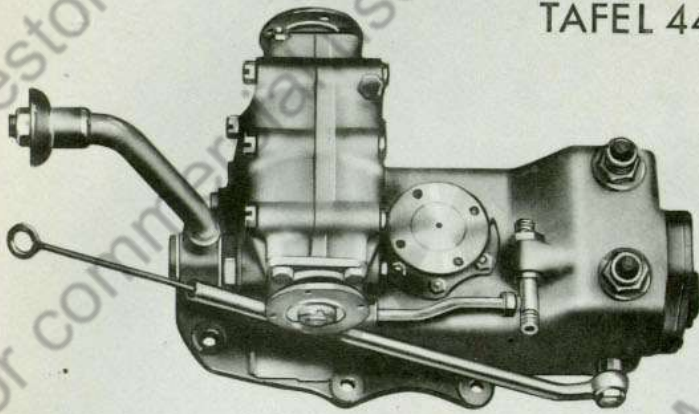

Gruppe: Antrieb für Lüfter

TAFEL 45

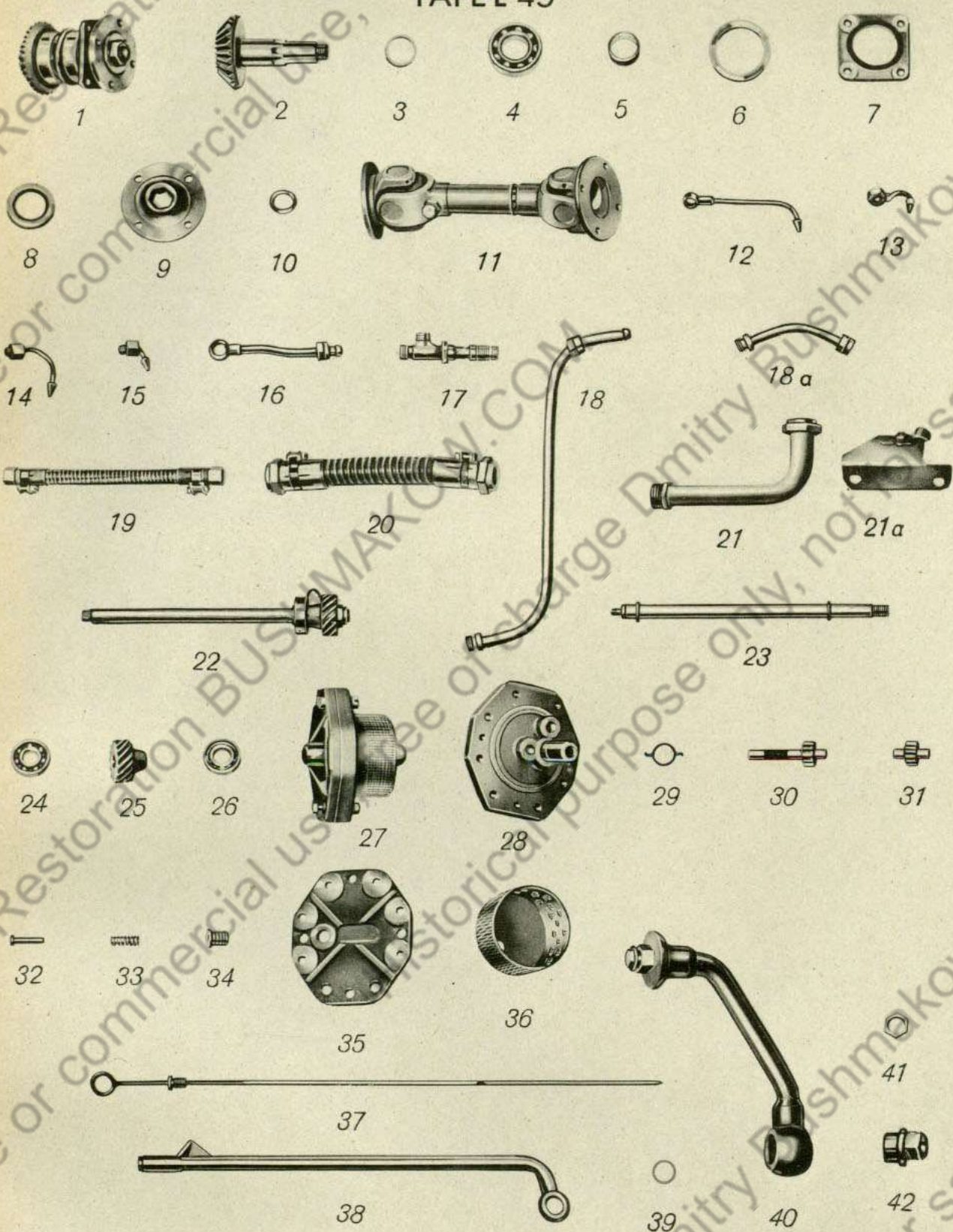

Gruppe: Antrieb für Lüfter

TAFEL 46

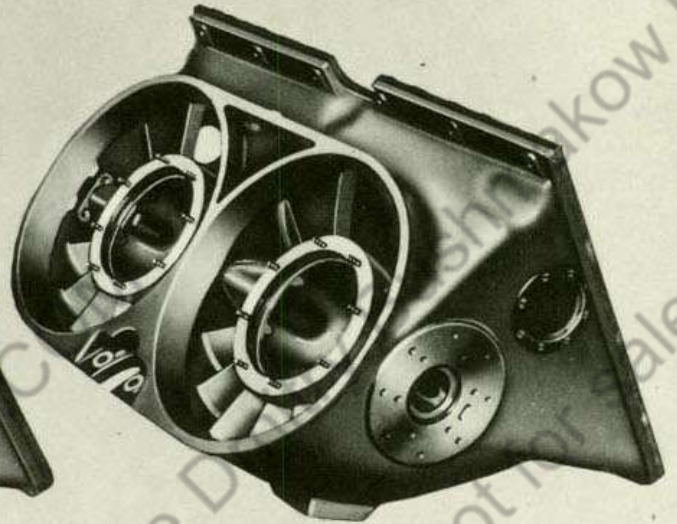
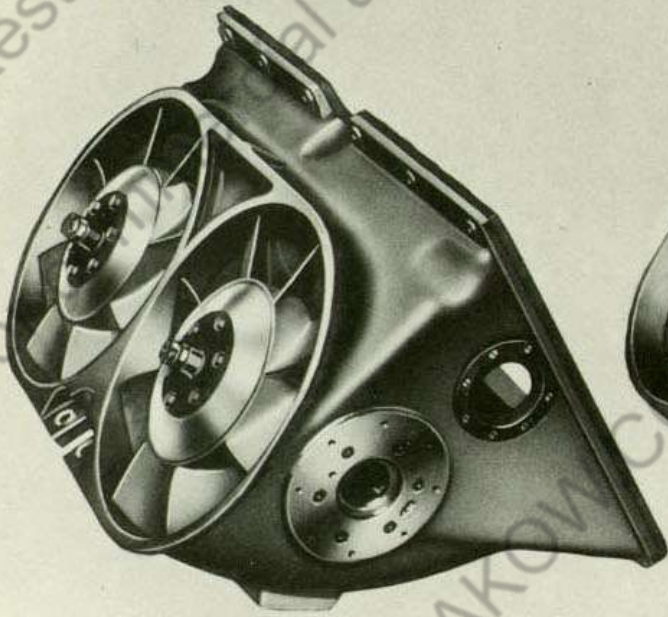

Gruppe: Kühlanlage [(1.) Lüfter]

TAFEL 47

1

2



3

4



5



6



7

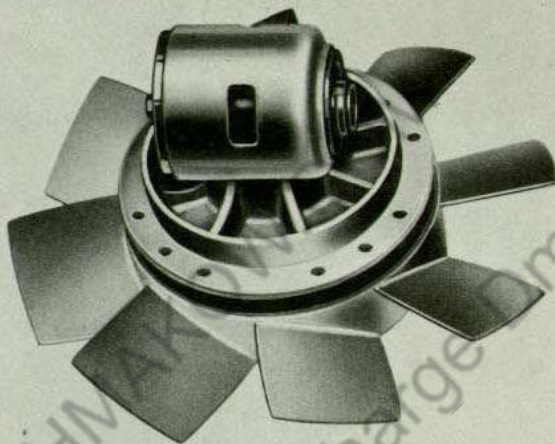

8



9



10



11



12

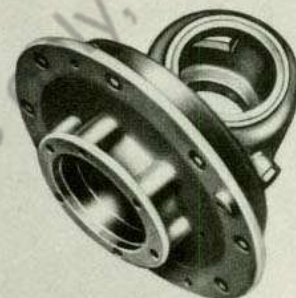

13



14

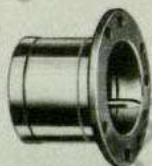

15

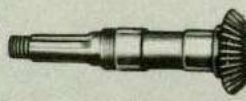

16



17



18



19

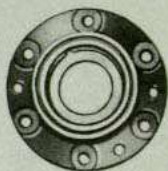

20



21



22



23

Gruppe: Kühlanlage [(1.) Lüfter]

TAFEL 48

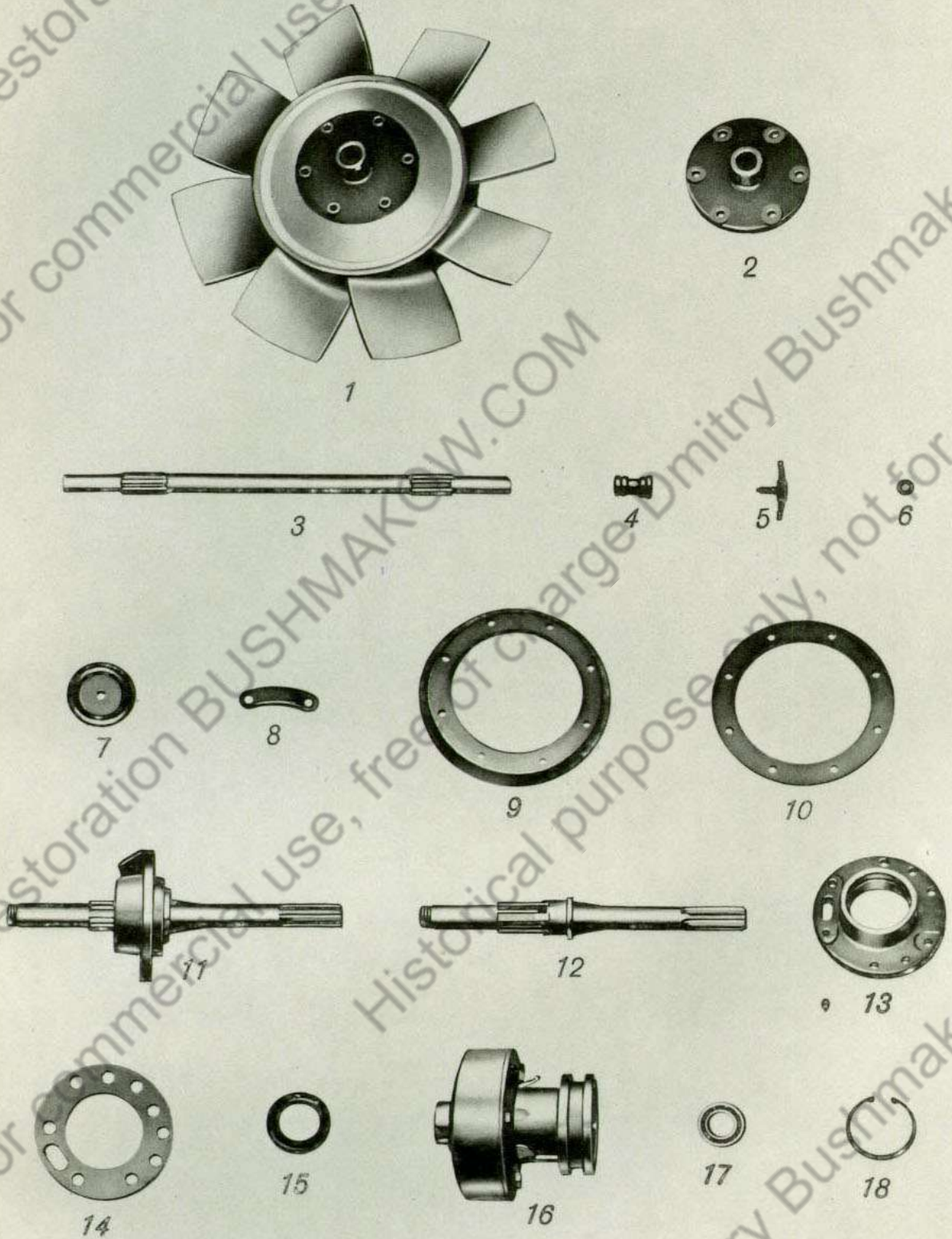

Gruppe: Kühlanlage [(1.) Lüfter]

TAFEL 49

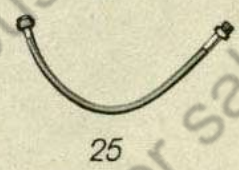
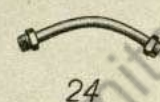
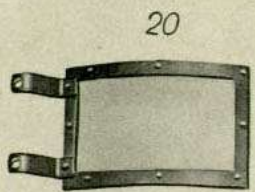
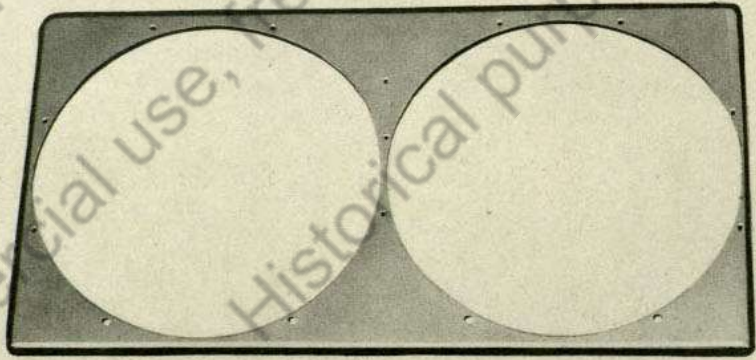
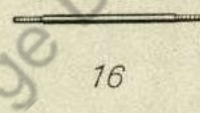
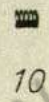
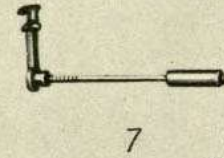
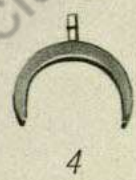
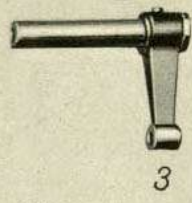
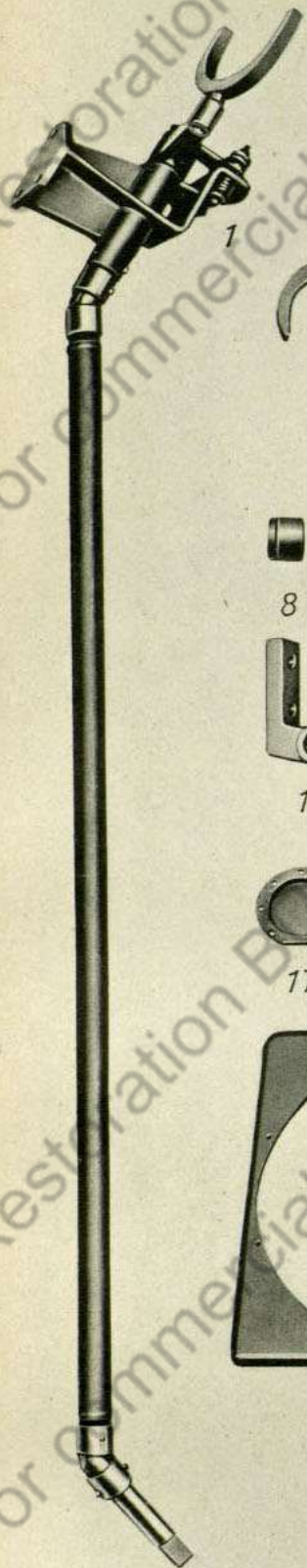

Gruppe: Kühlanlage

TAFEL 50

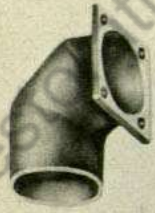

1



2

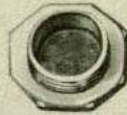

3



4



5



6



7

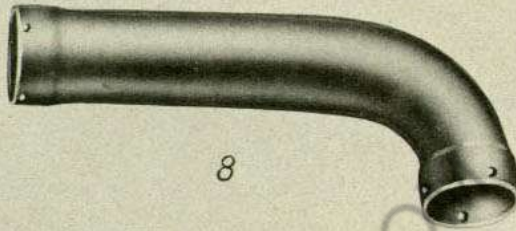

8



9



10

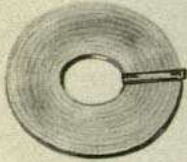

11

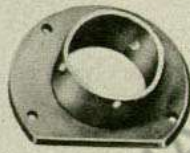

12

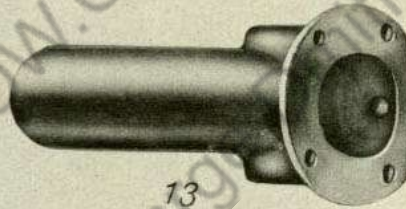

13

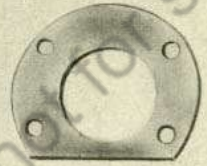

14



15



16



17

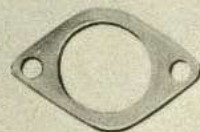

18



19

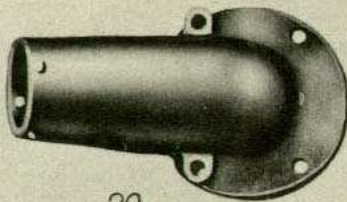

20

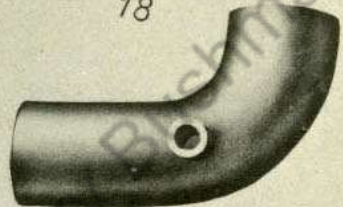

21

Gruppe: Kühlanlage

TAFEL 51

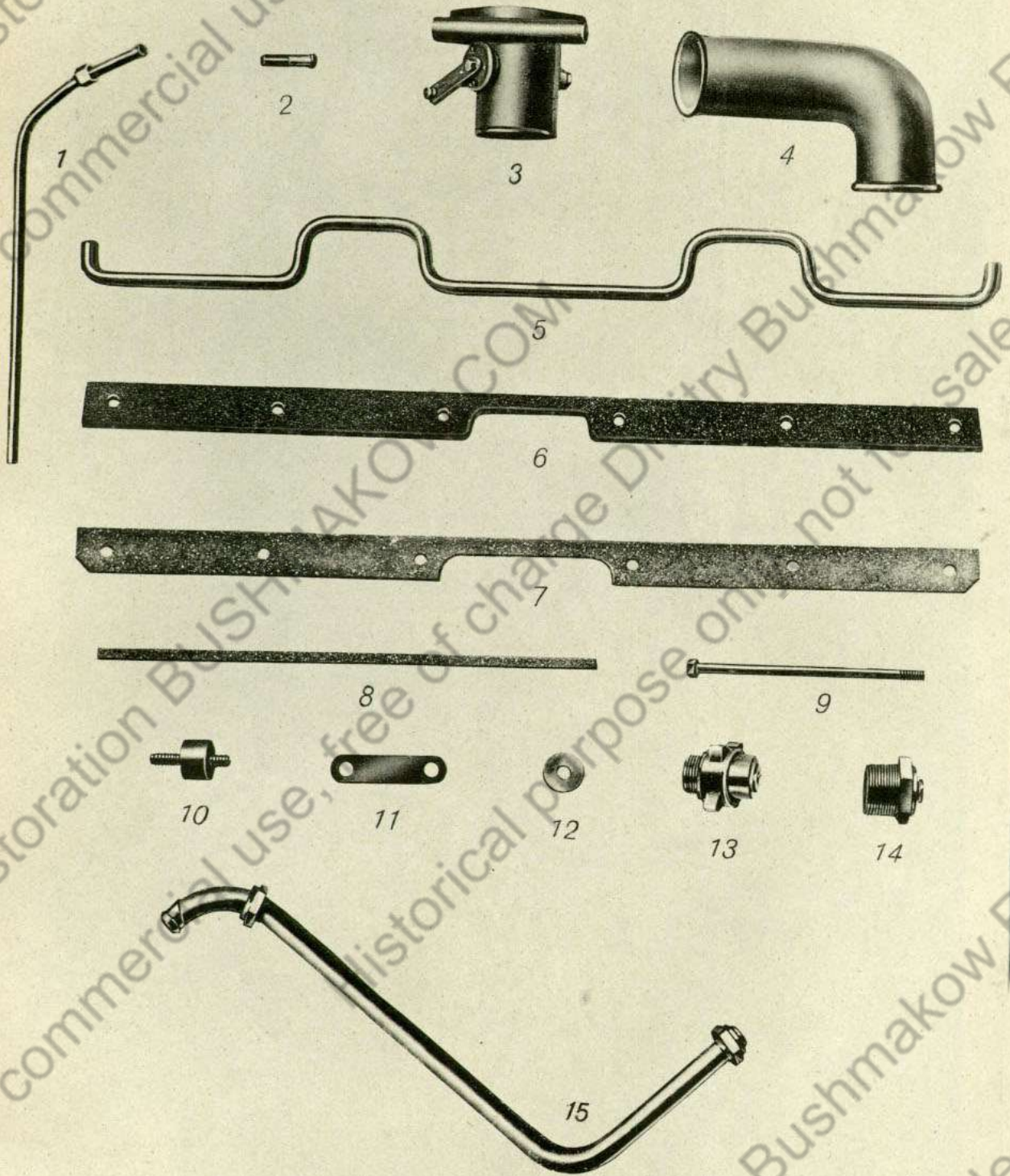

Gruppe: Kühlanlage

TAFEL 52

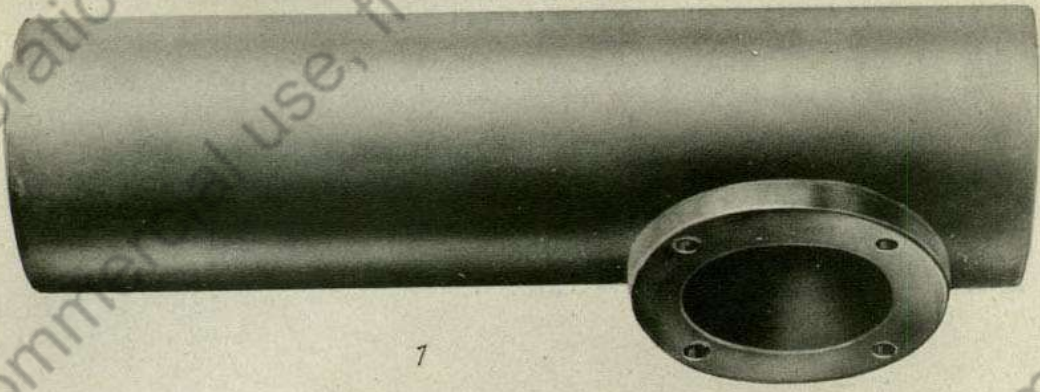

1

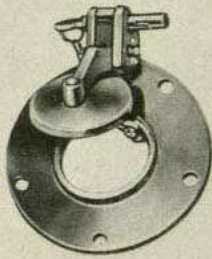

2

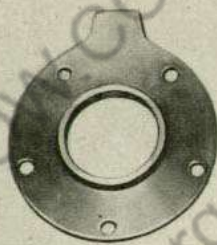

3



4



5



6



7

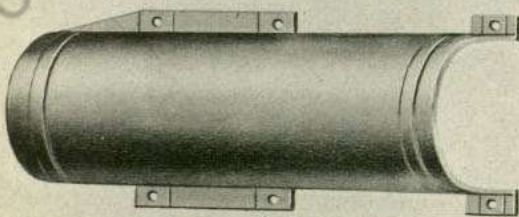

8



9

Gruppe: Auspuff

TAFEL 53

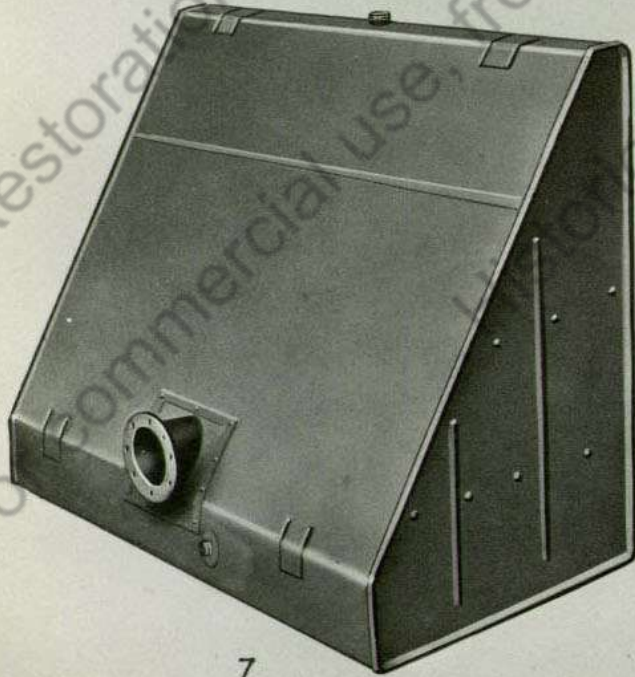
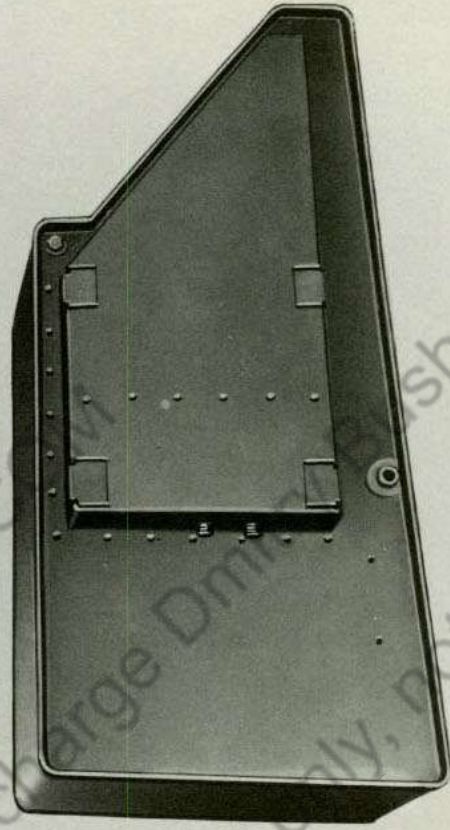
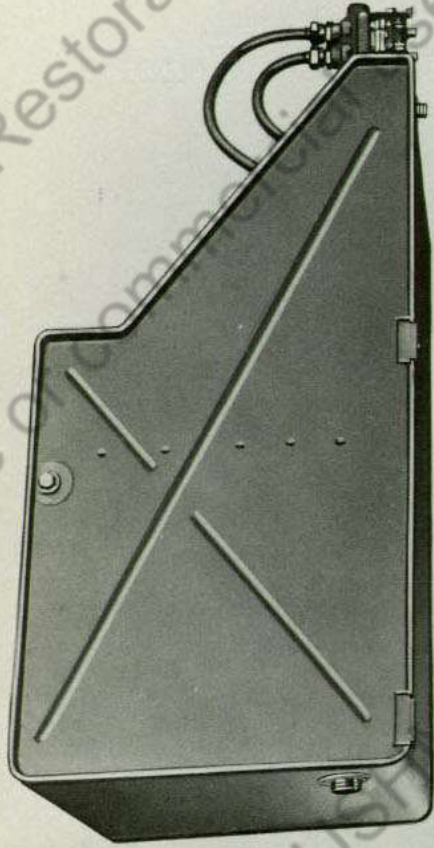

Gruppe: Kraftstoffbehälter

TAFEL 54

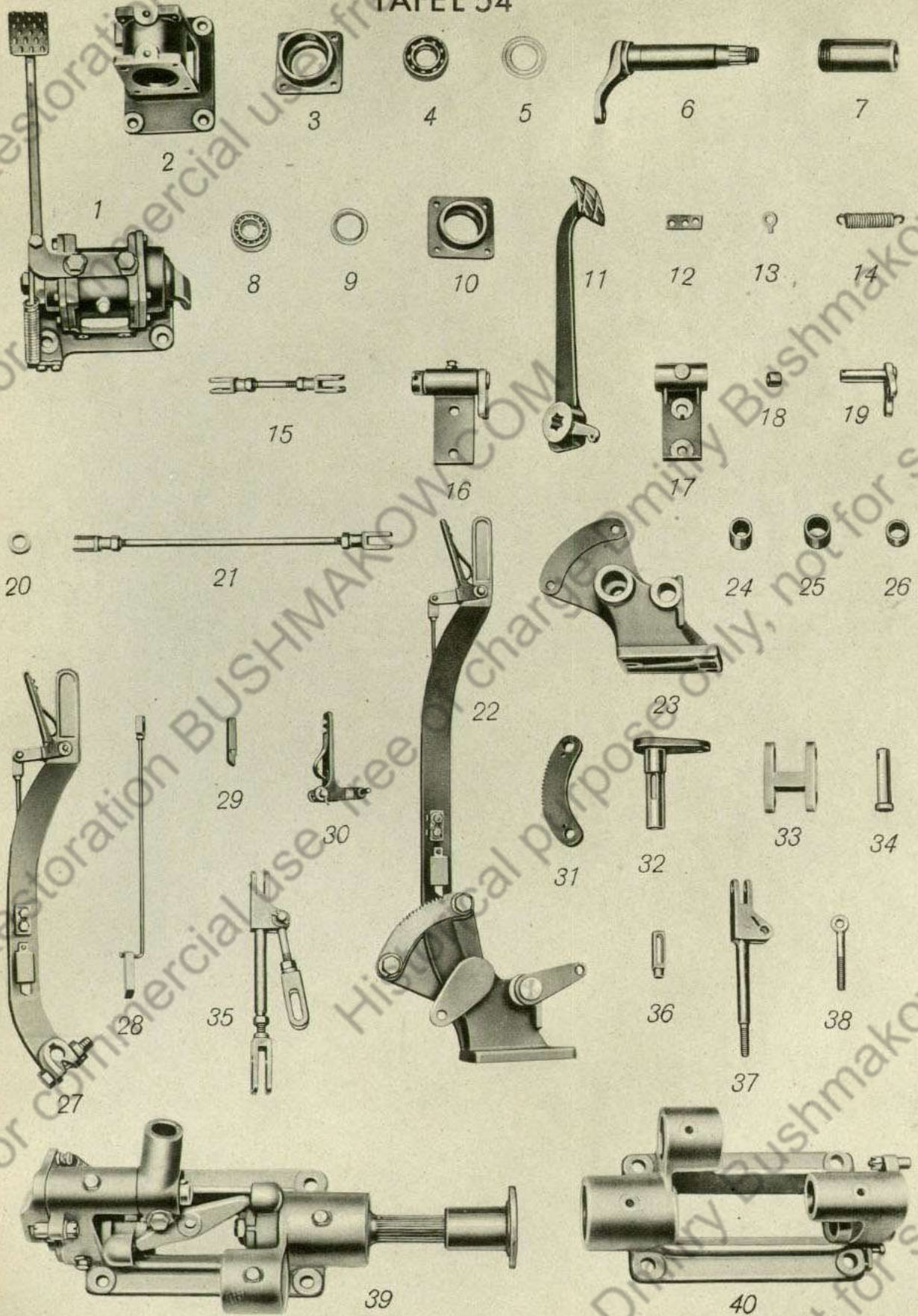

Gruppe: Hand- und Fußhebelwerk

TAFEL 55

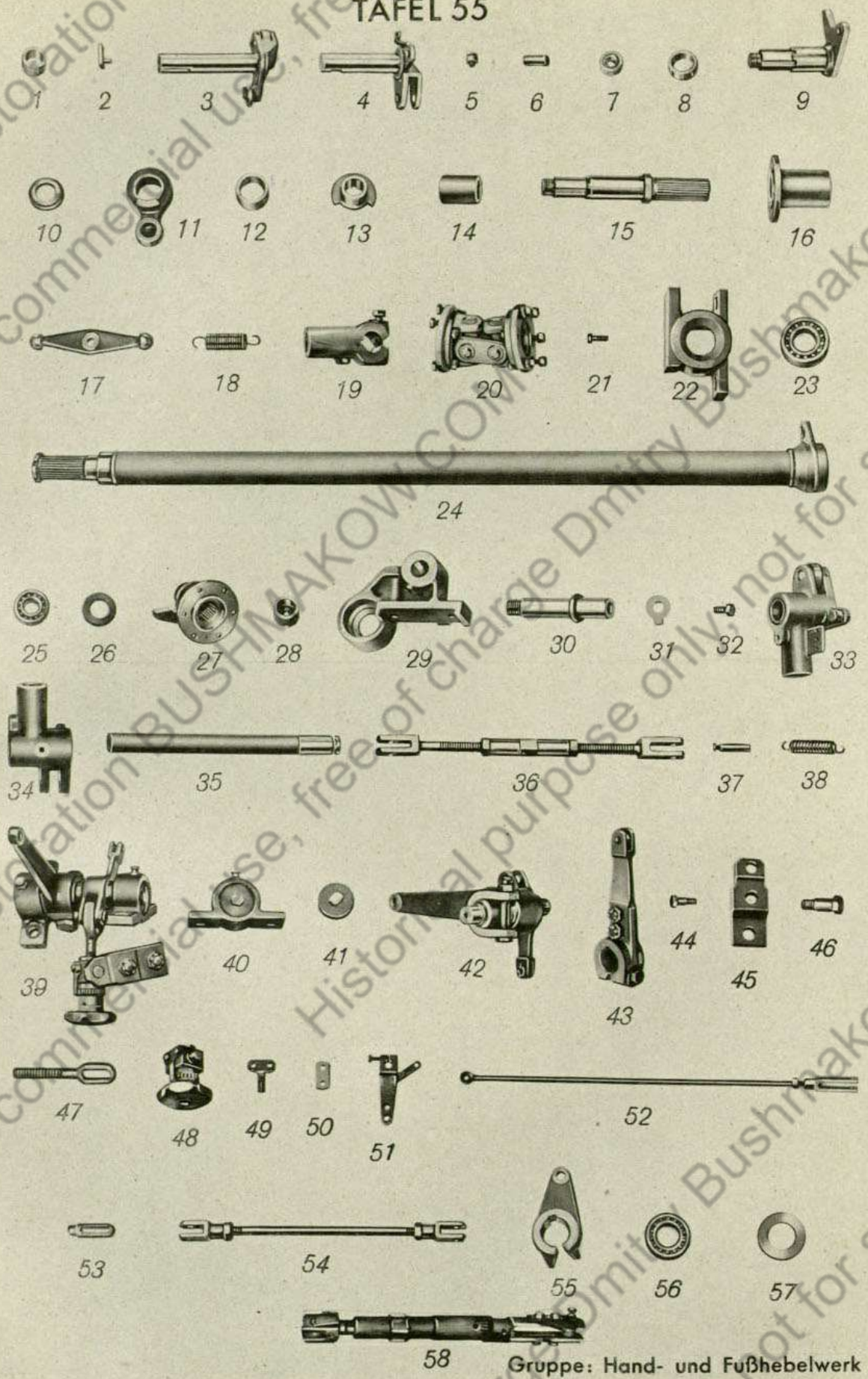

Gruppe: Hand- und Fußhebelwerk

TAFEL 56

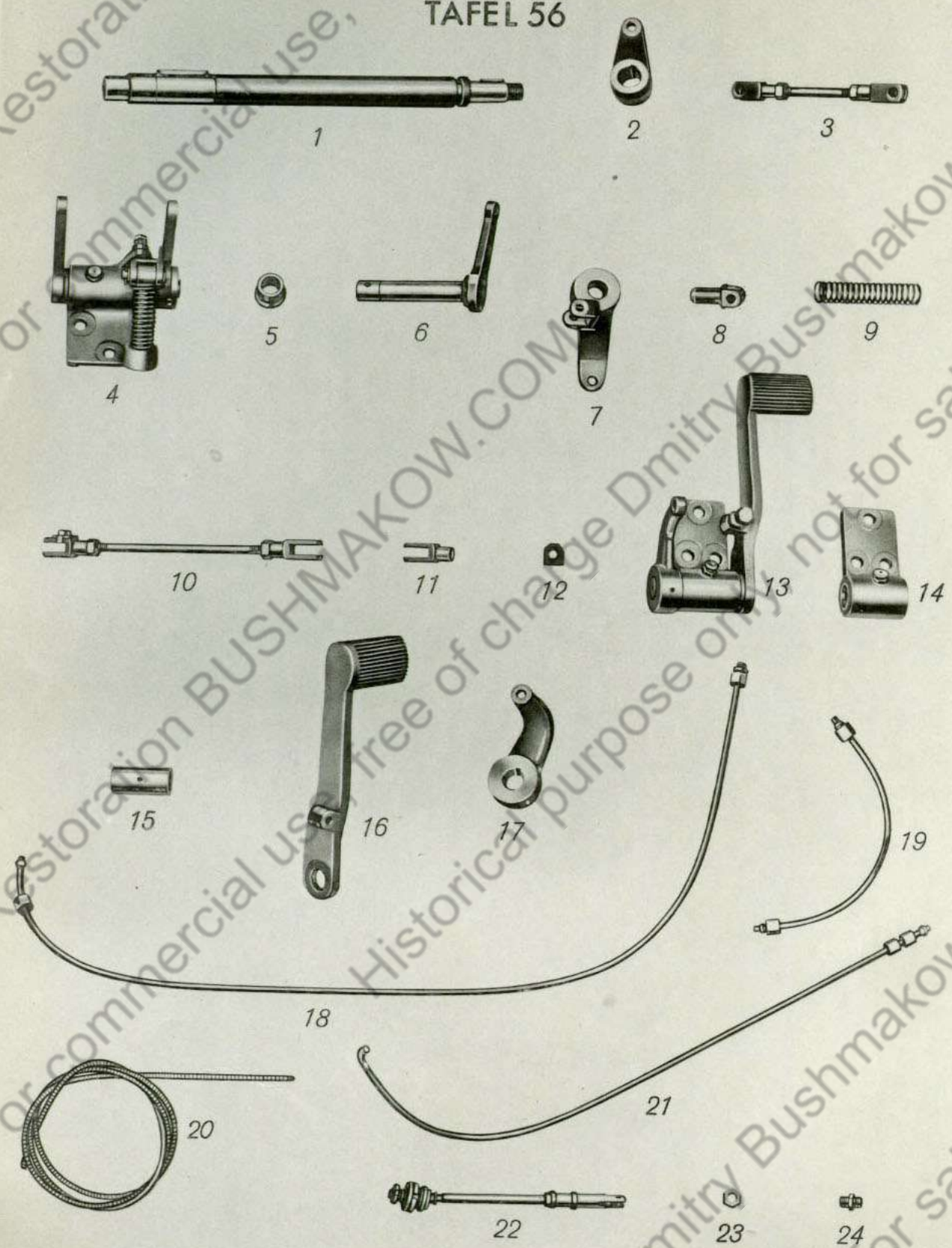

Gruppe: Hand- und Fußhebelwerk

TAFEL 57

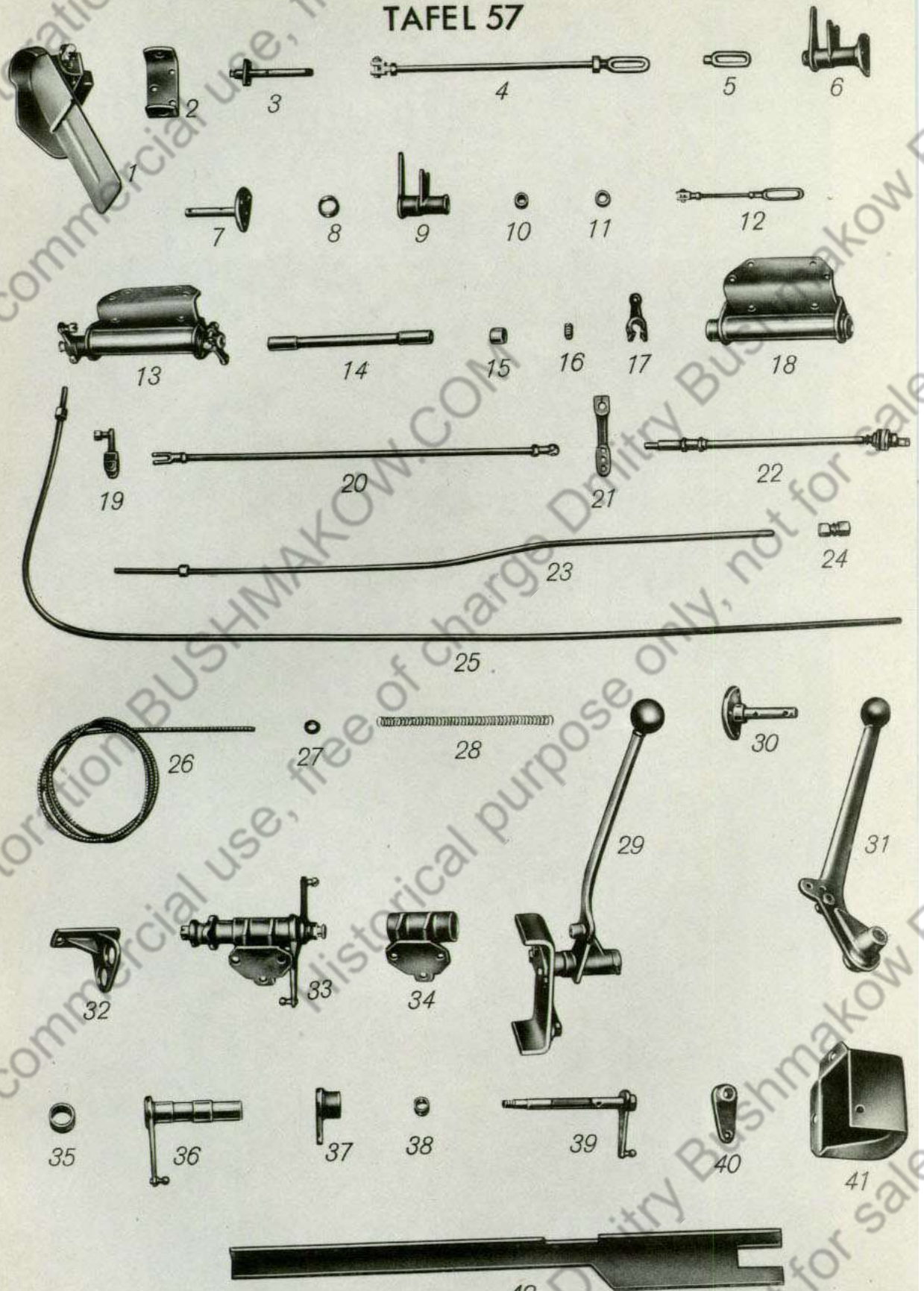

Gruppe: Gas- und Startergestänge

TAFEL 58

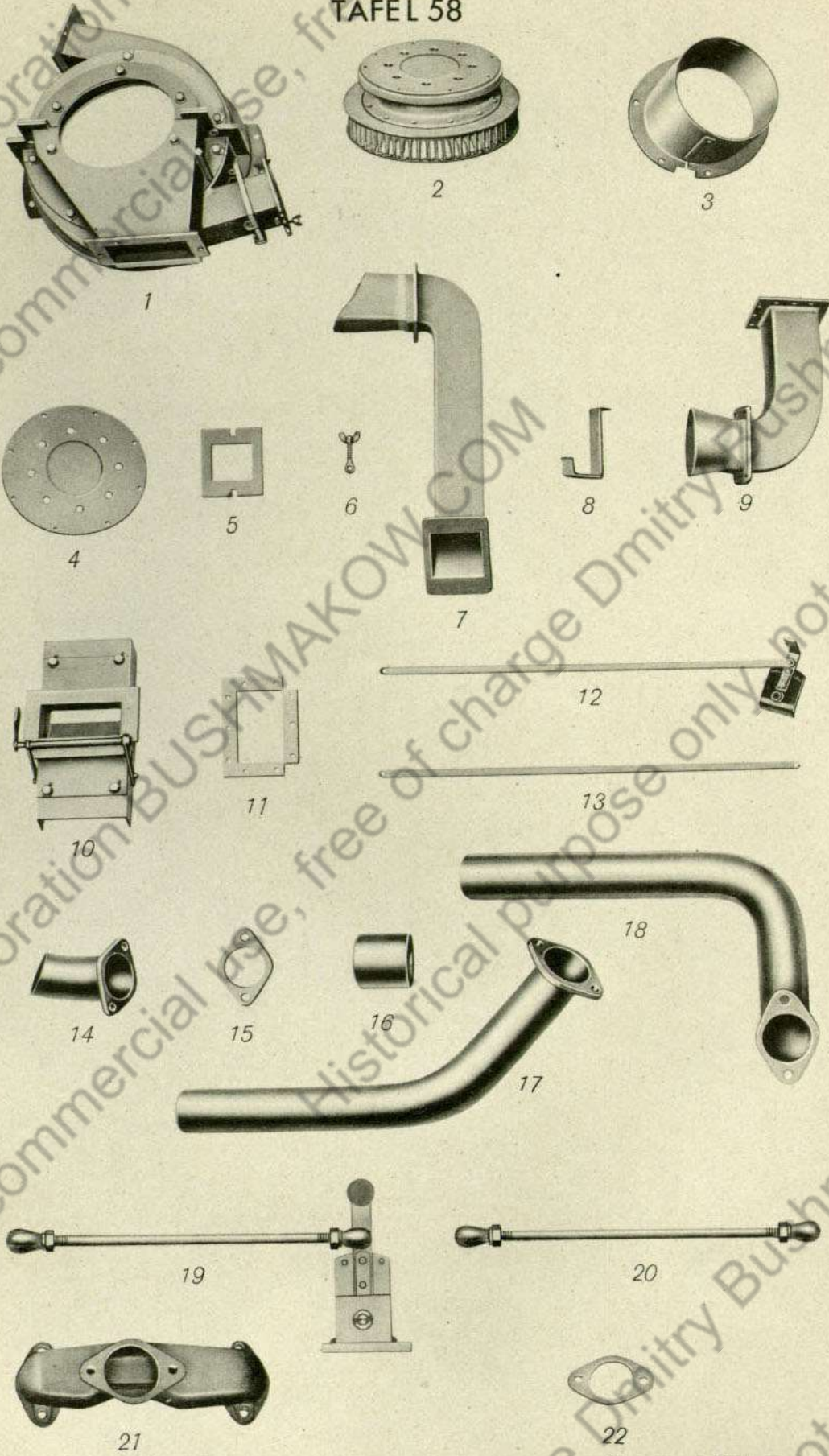

Gruppe: Luftabsaugung

TAFEL 59



1



2



3

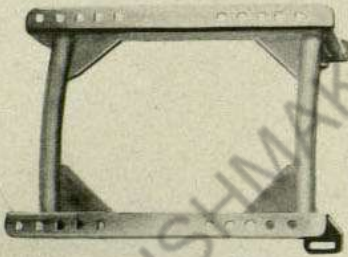

4

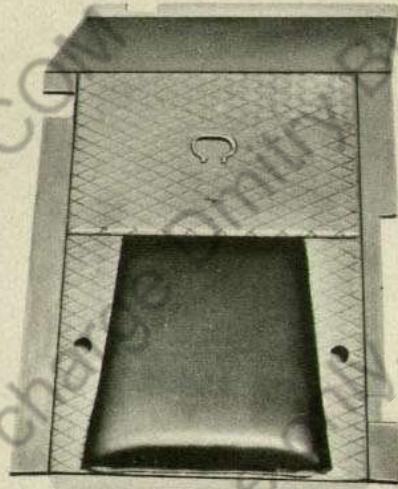

5

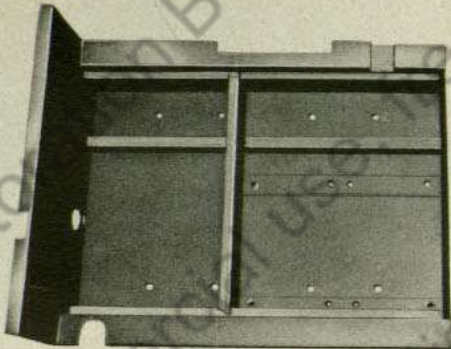

6

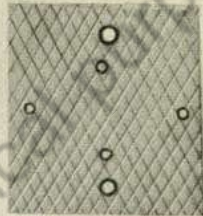

7



8



9



10



11

Gruppe: Sitze

TAFEL 60

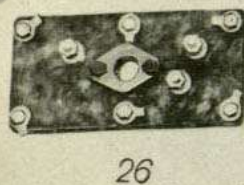
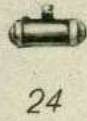
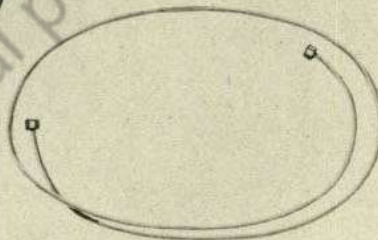
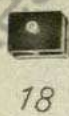
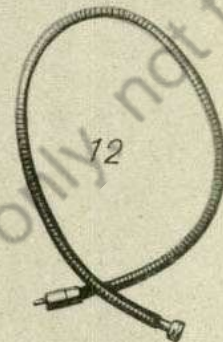
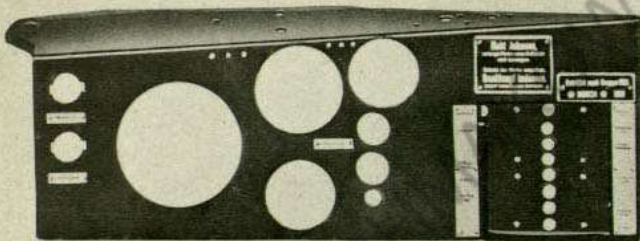
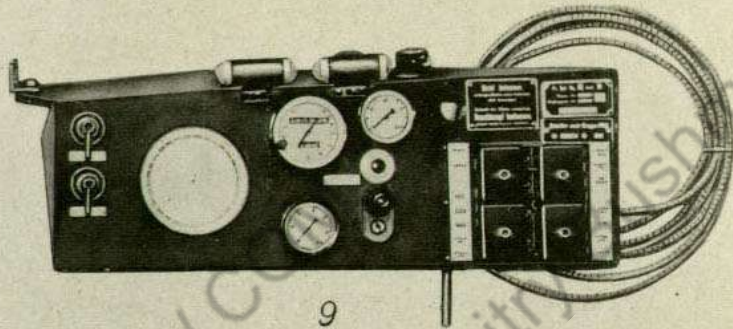
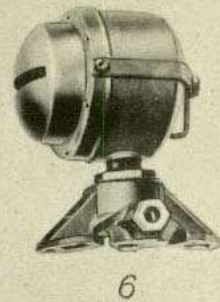
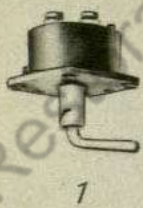

Gruppe: Elektr. Anlage

TAFEL 61

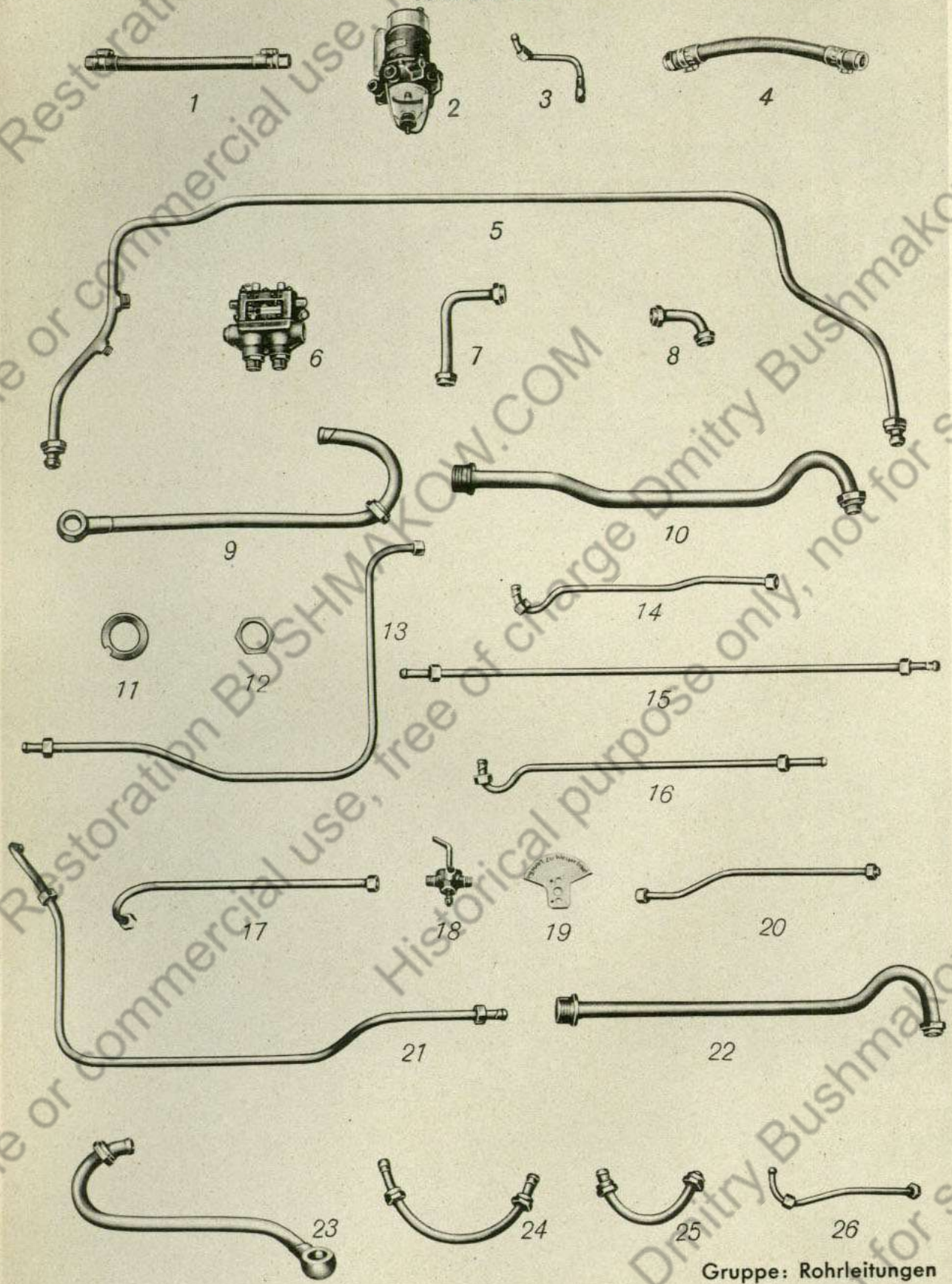

Gruppe: Rohrleitungen

TAFEL 62

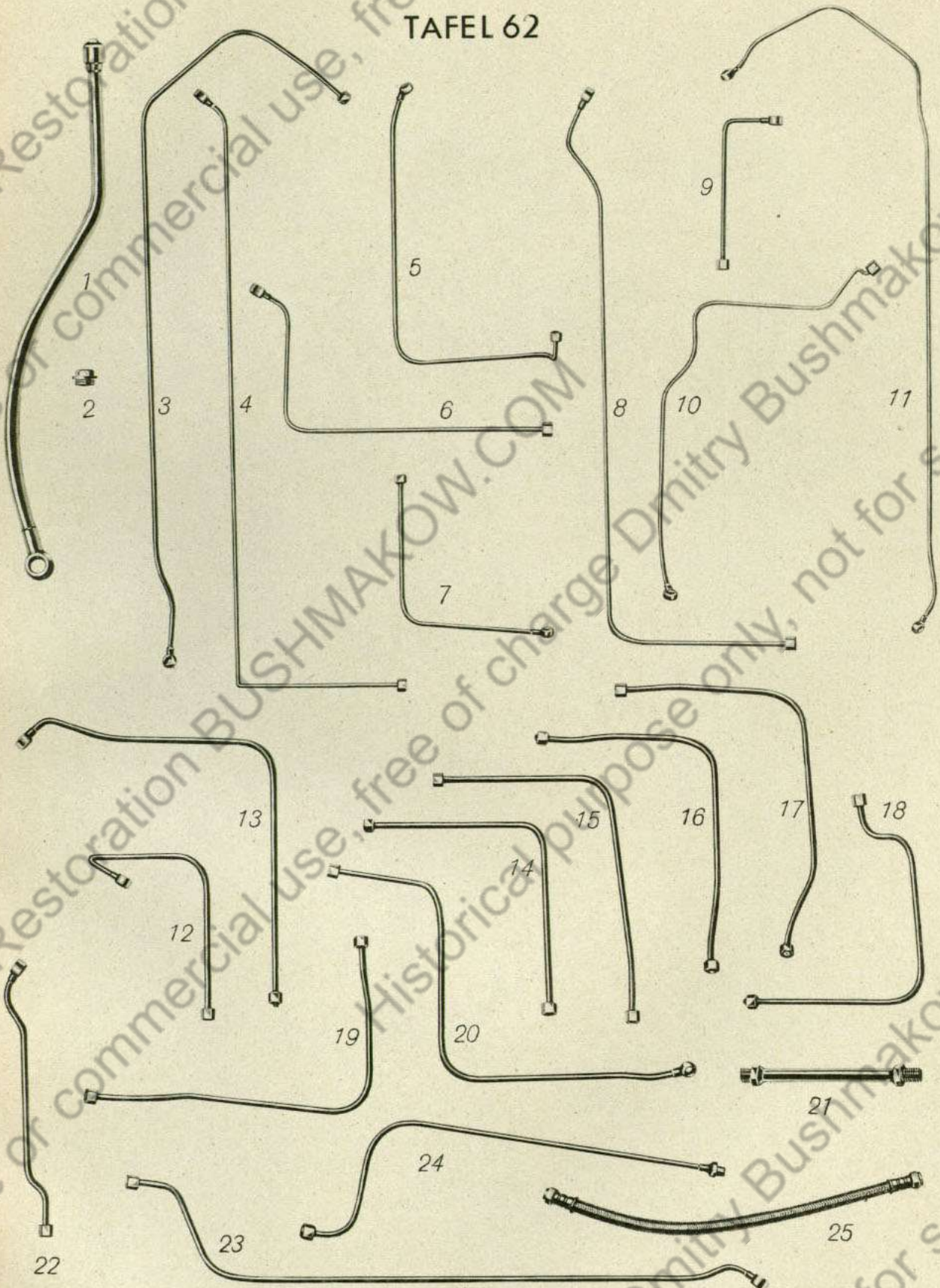

Gruppe: Rohrleitungen

TAFEL 63

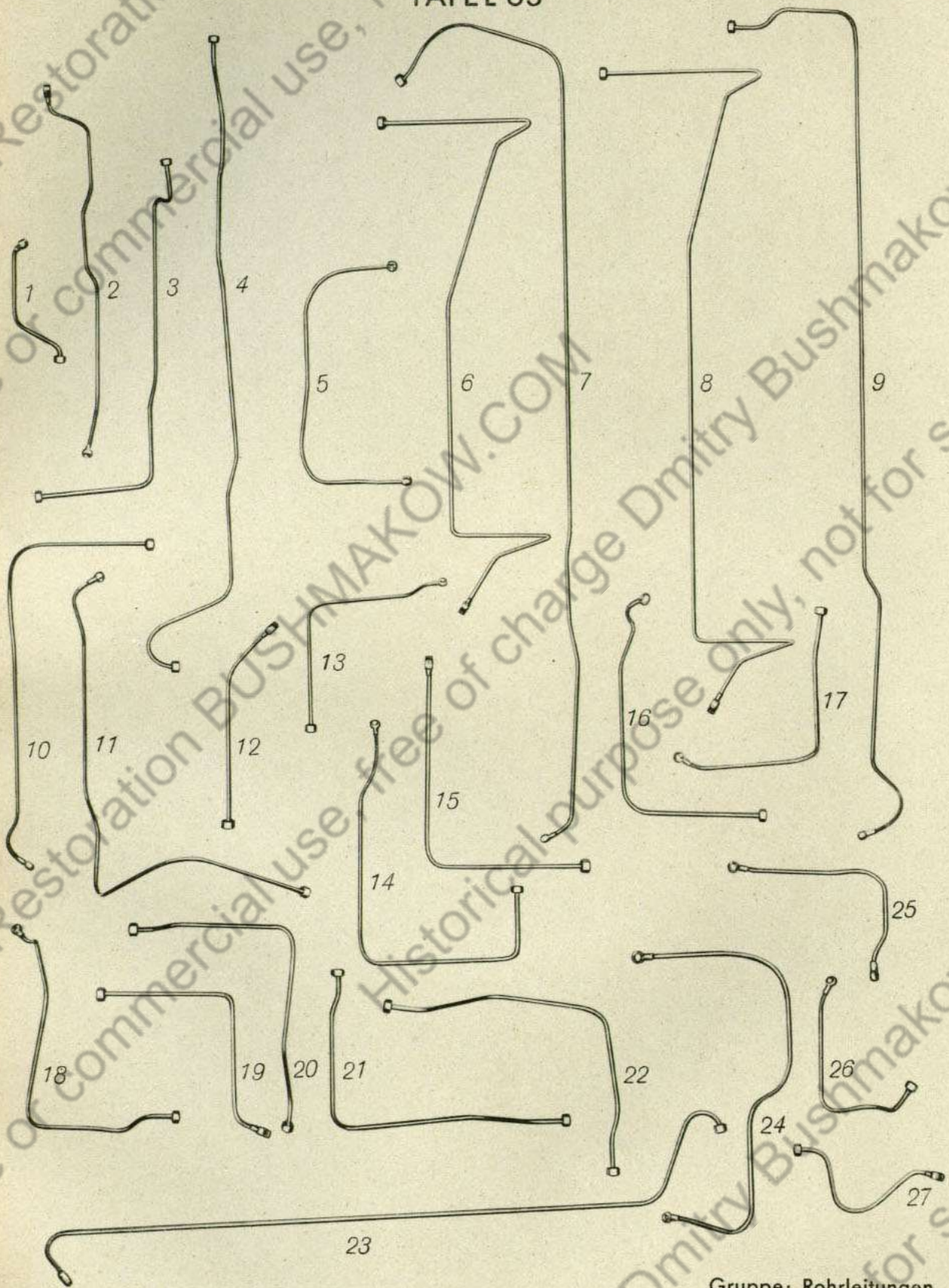

Gruppe: Rohrleitungen

TAFEL 64

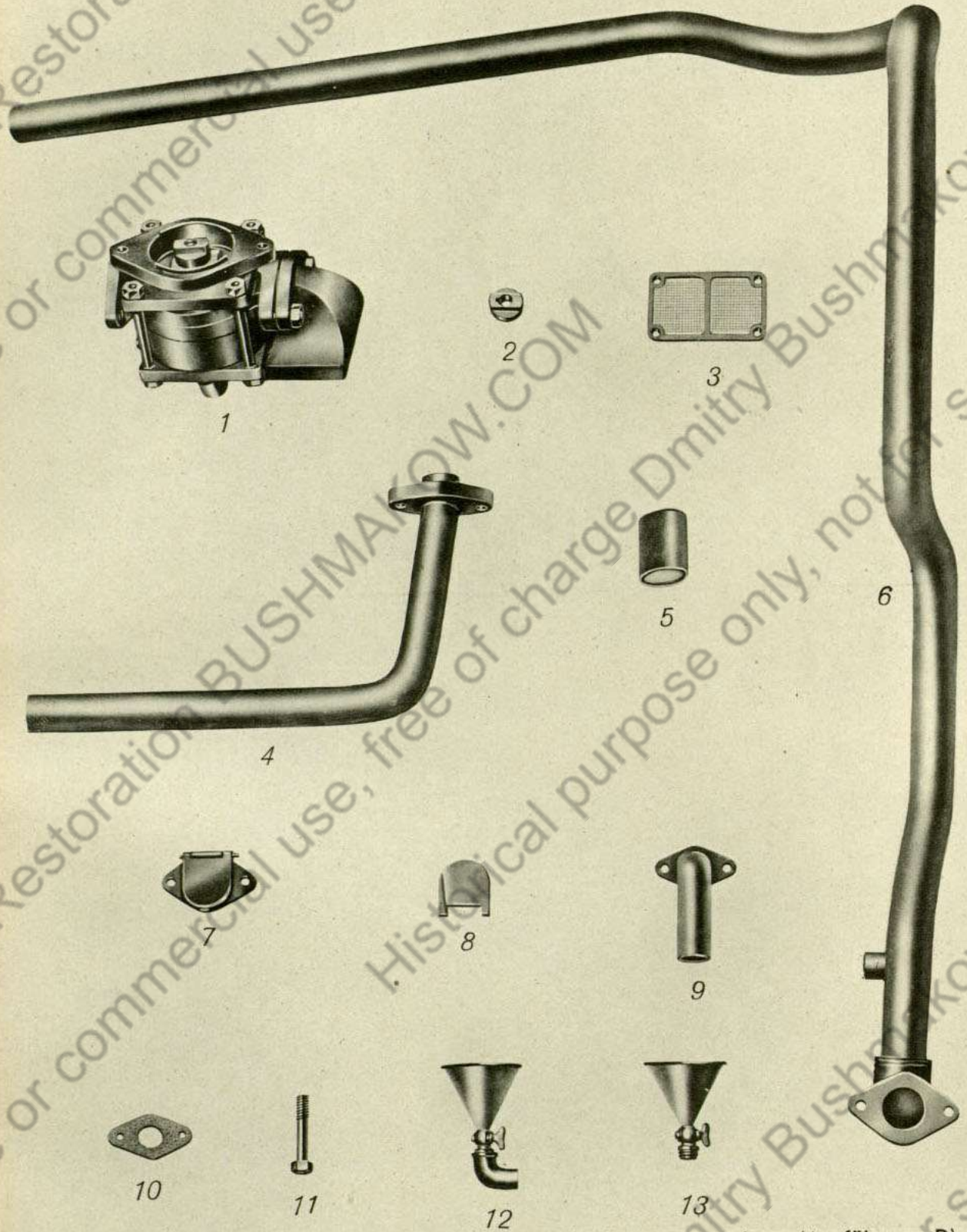

Gruppe: Lenzanlage (Ausführung D)

TAFEL 65

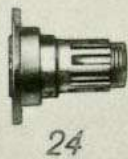
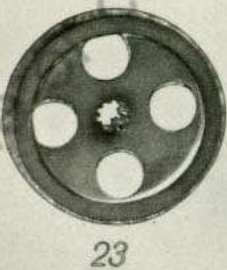
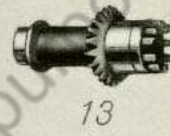
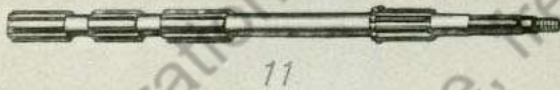
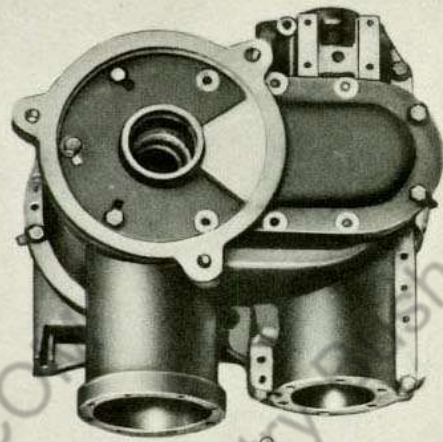
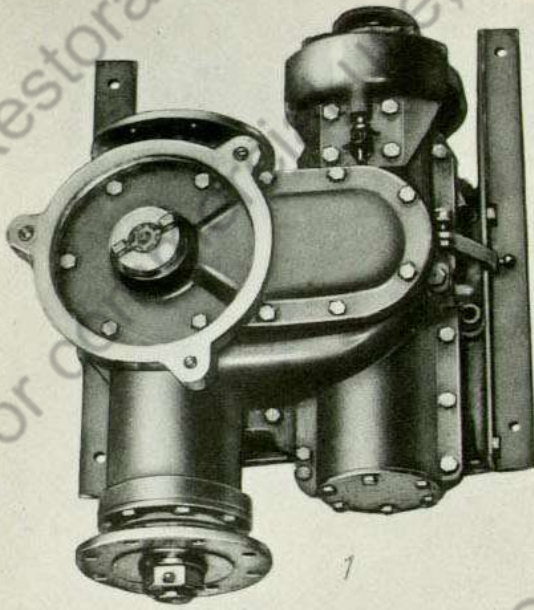

Gruppe: Turmantrieb

TAFEL 66

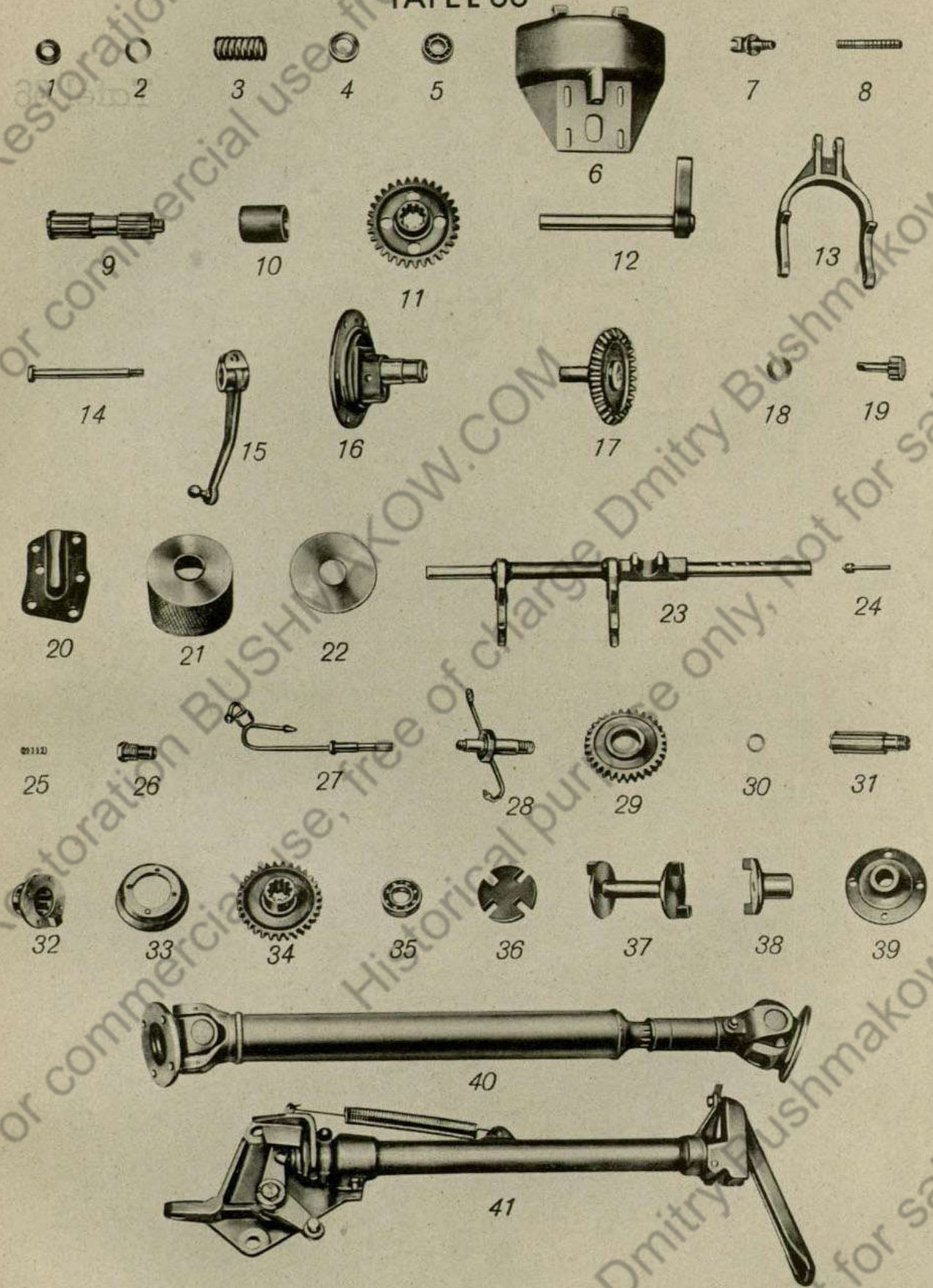

Gruppe: Turmantrieb

TAFEL 67

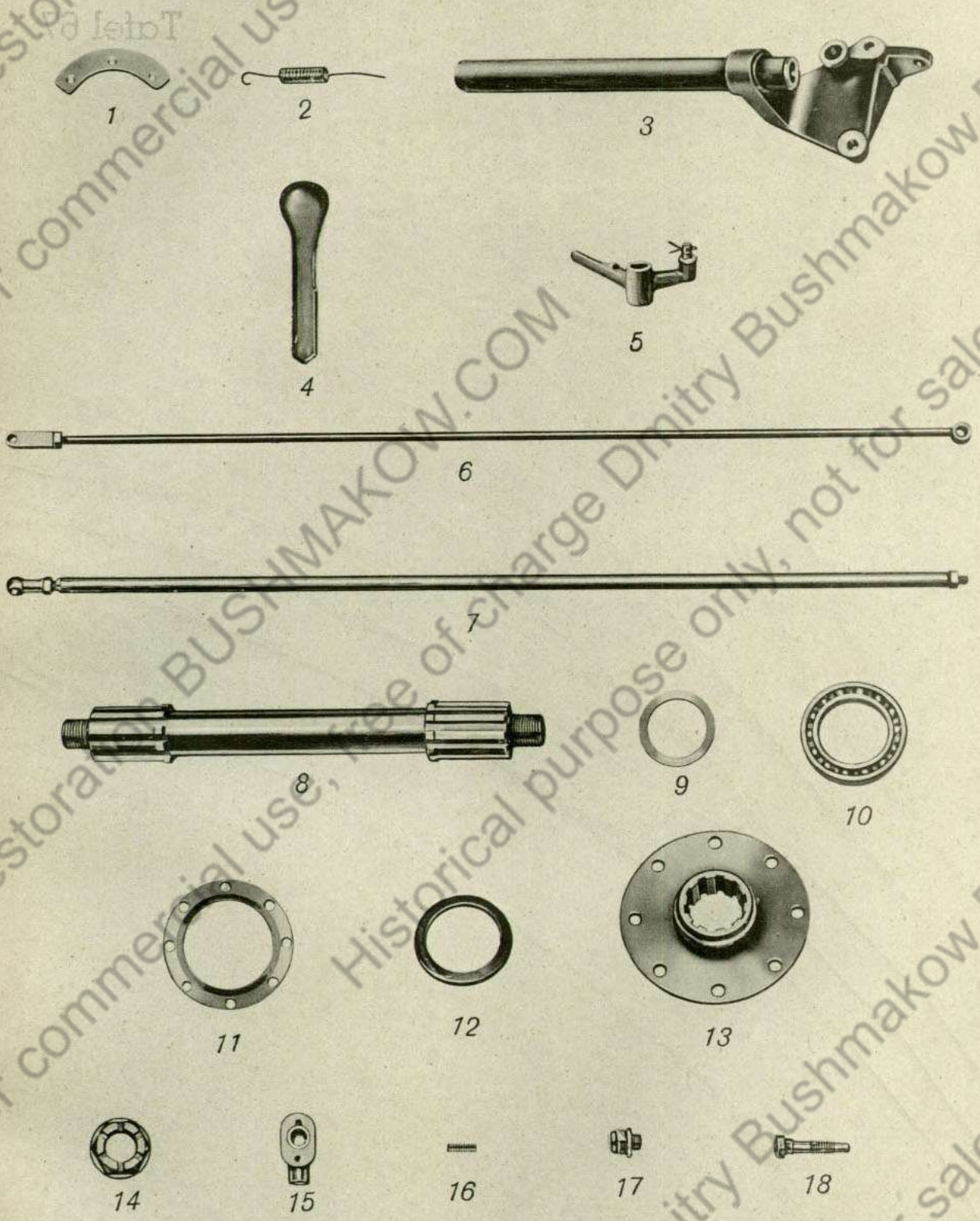

Gruppe: Turmantrieb

TAFEL 68

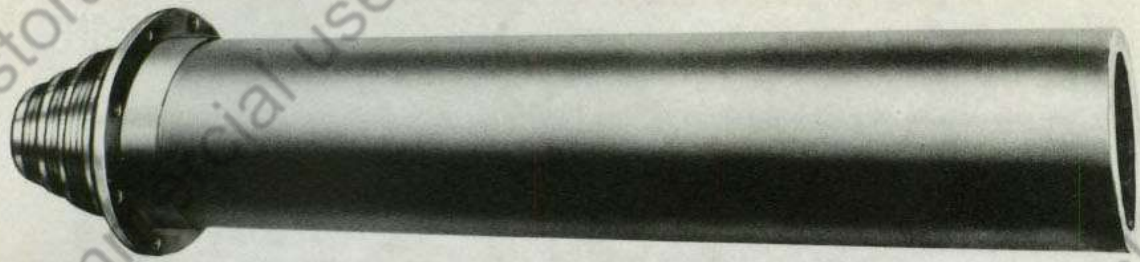

1

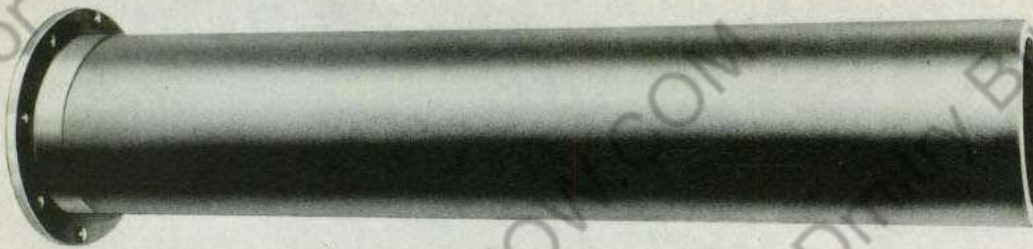

2

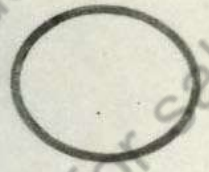

3



4



5

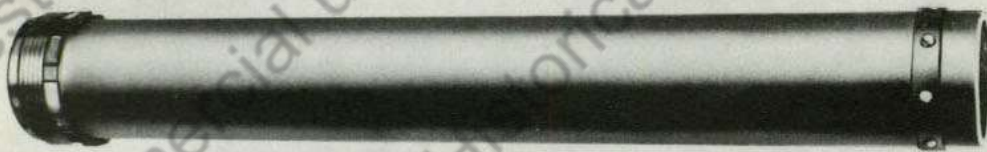

6



7



8



9



10

Gruppe: Motor-Lufrohr



TAFEL 69

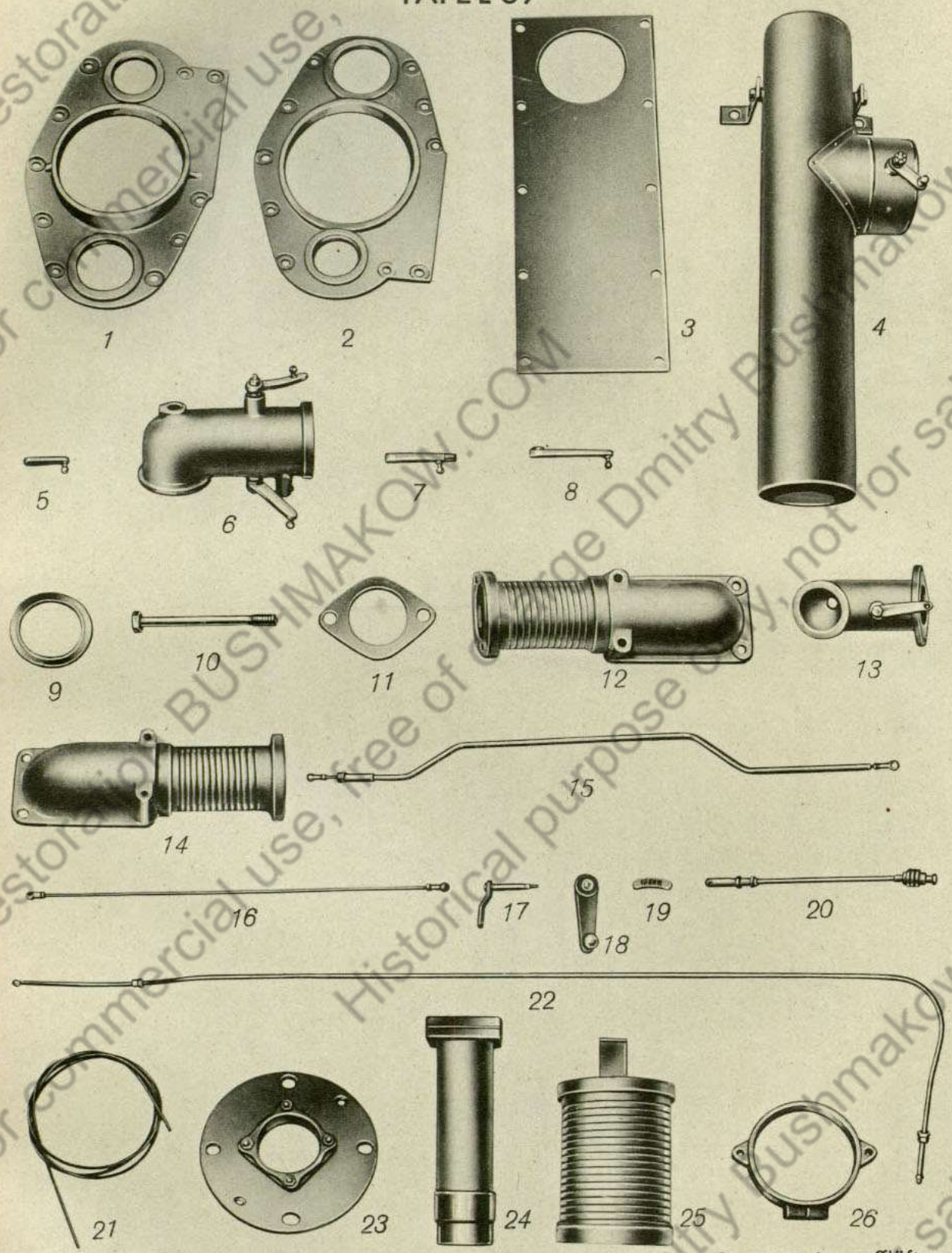

Gruppe: Auspufflüftung

TAFEL 70



1

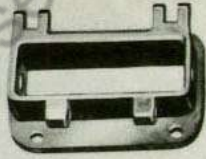

2

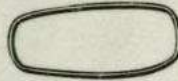

3

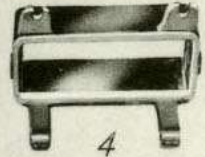

4

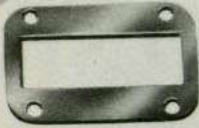

5



6



7



8



9



10

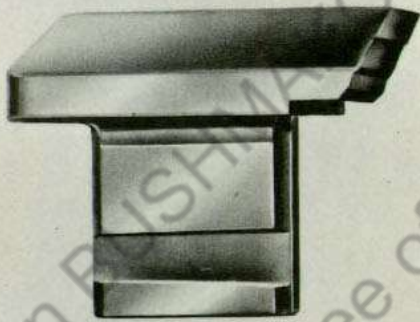

11

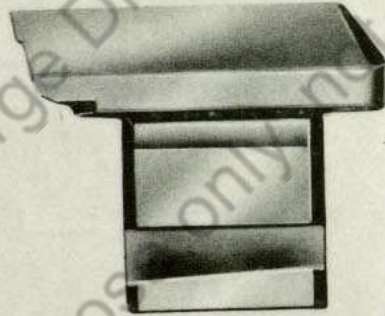

12

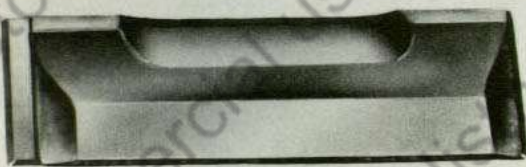

13



14



15



16



17

Gruppe: Winkelspiegel (Bild 1-10)

Gruppe: Fahrersehklappe (Bild 11-17)

TAFEL 71

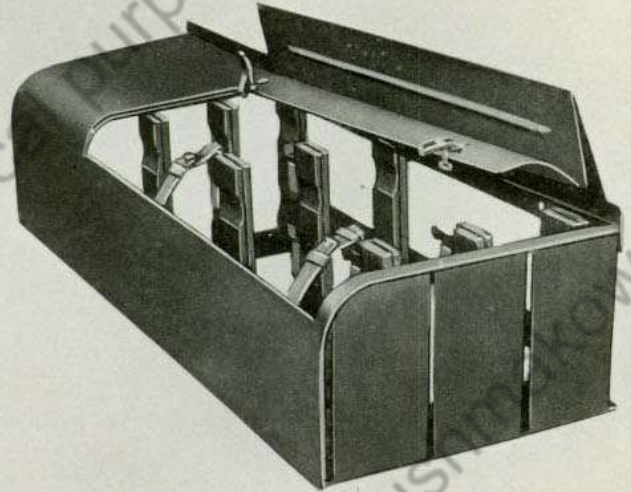
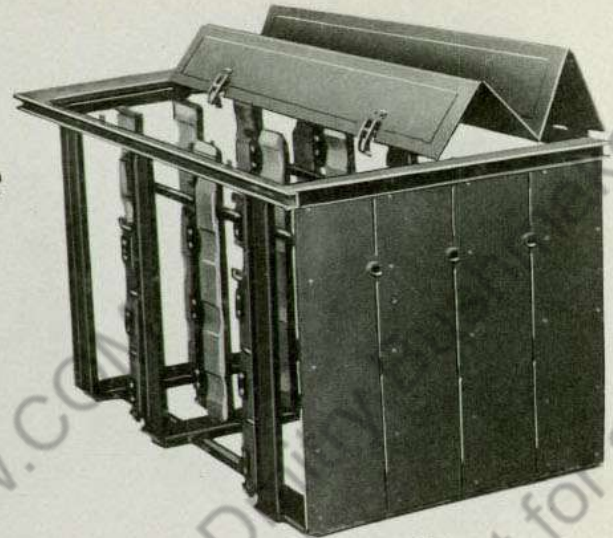
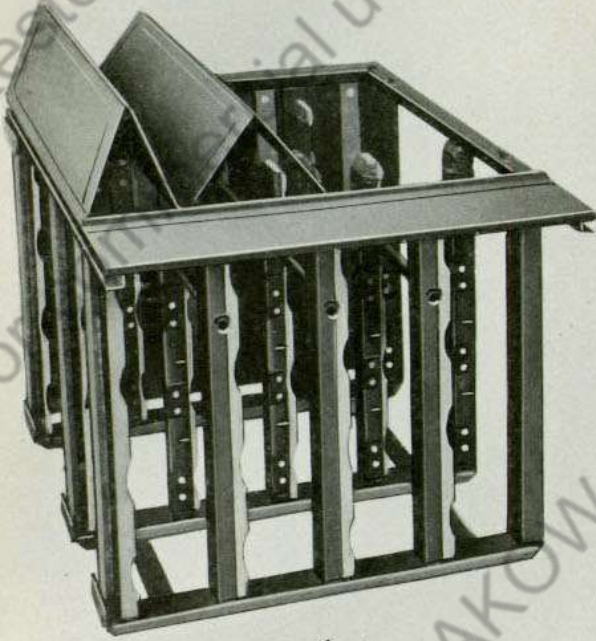

Gruppe: Munitionsträger

TAFEL 72

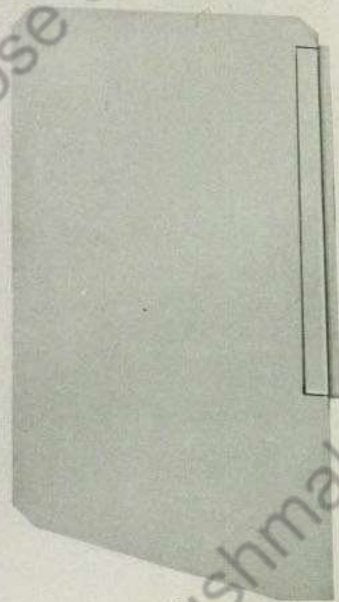
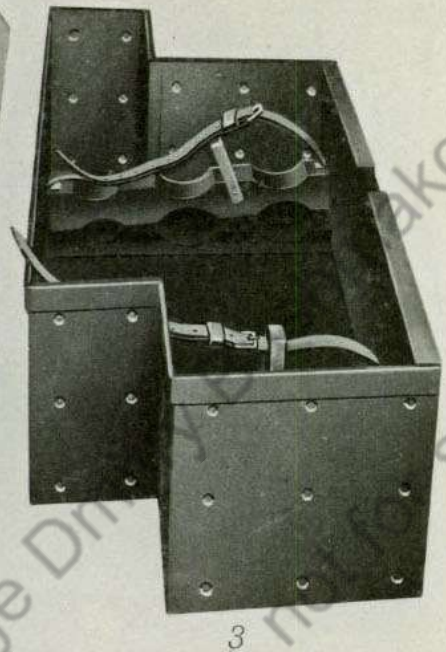
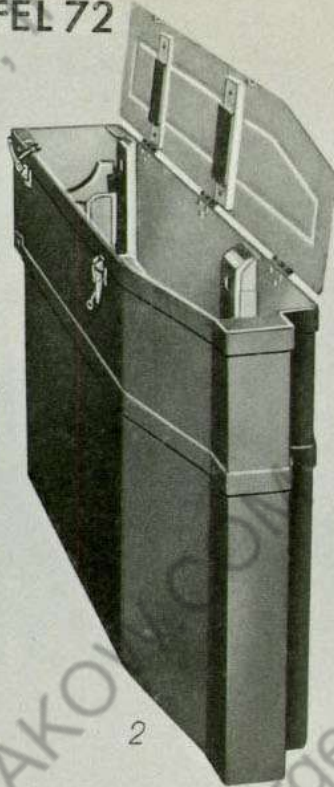
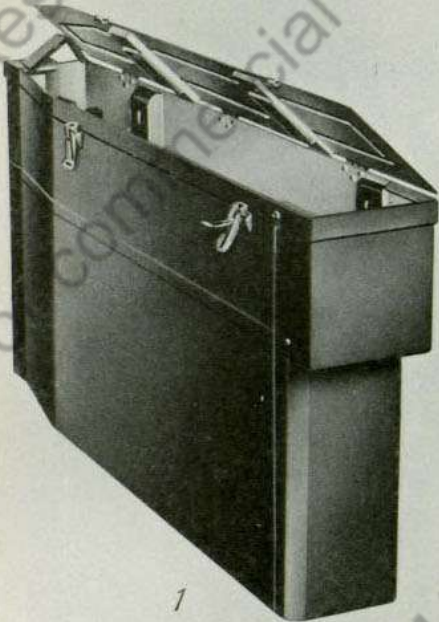

Gruppe: Munitionsträger

TAFEL 73

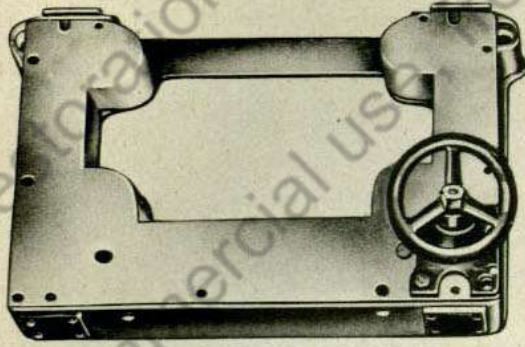

1



2



3



4



5



6



7



8



9



10



11



12

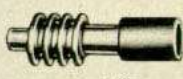

13



14

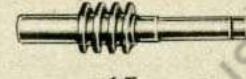

15



16



17



18



19



20



21



22

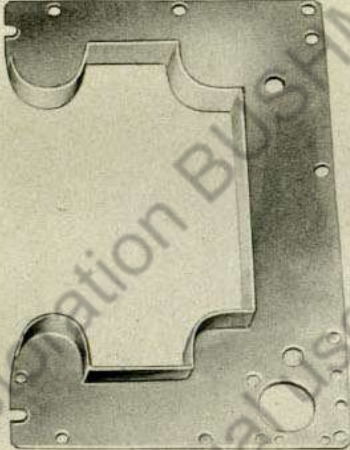

23



24



25



26



27

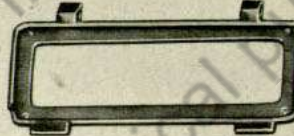

28



29



30



31



32



33



34

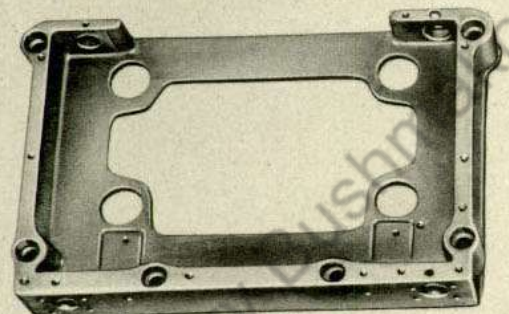

35

Gruppe: Betätigung der Fahrersehklappe

TAFEL 75

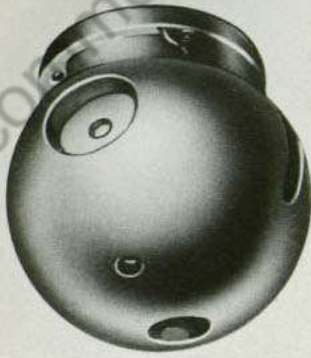

1

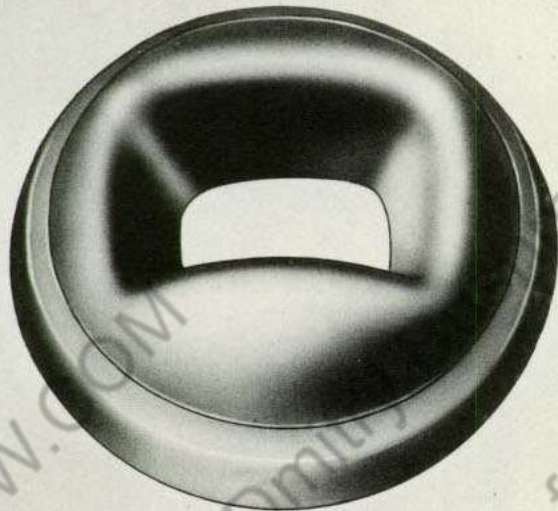

2



3



4

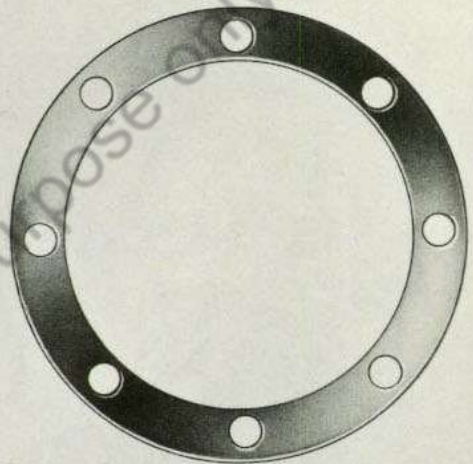

5



6



7

Gruppe: Kugelblende

TAFEL 76

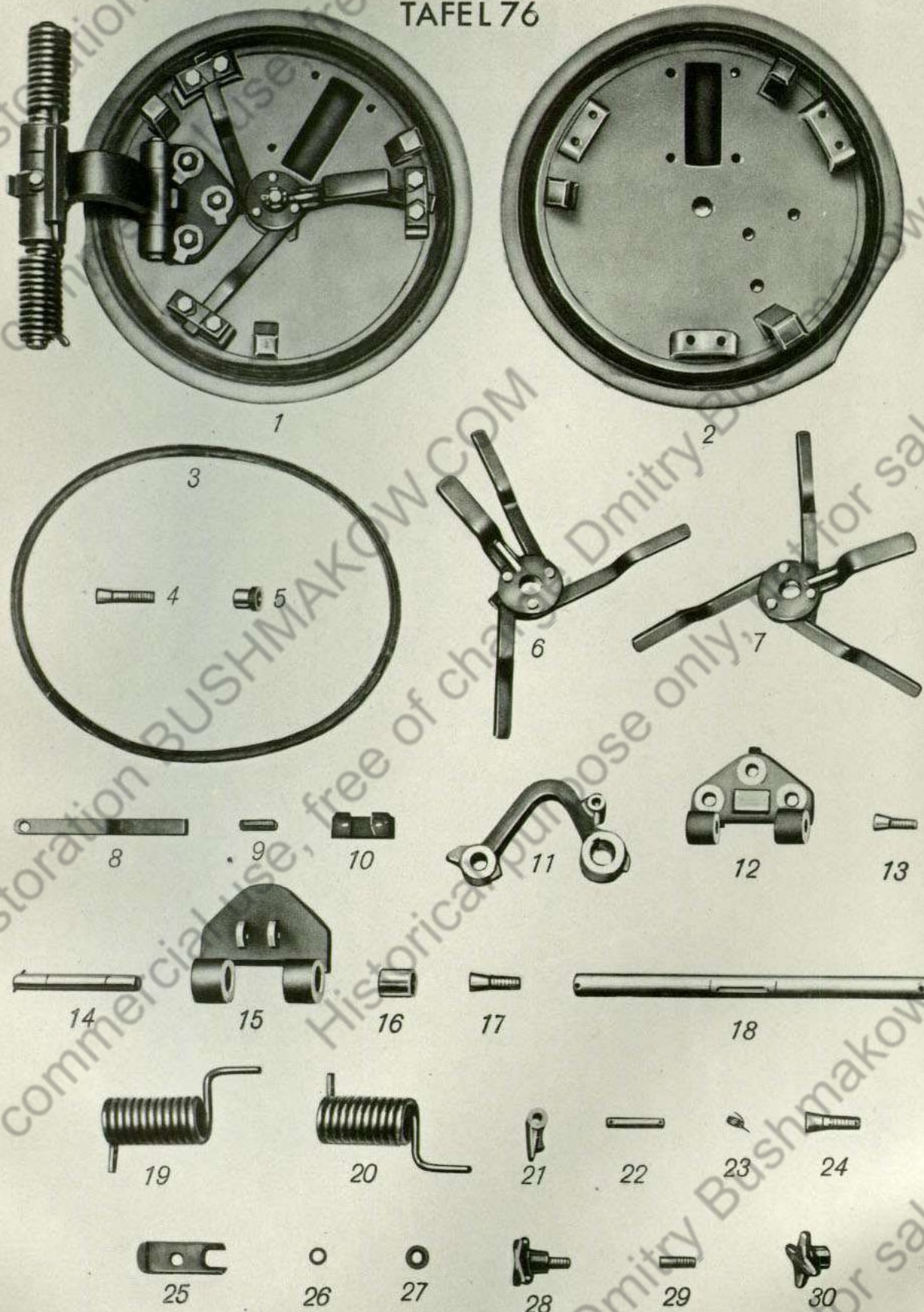

Gruppe: Einstieglukendeckel, links und rechts

TAFEL 77

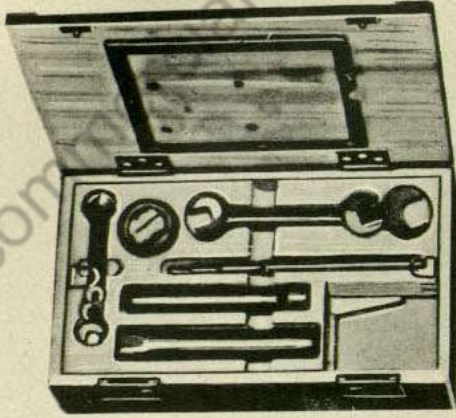

1

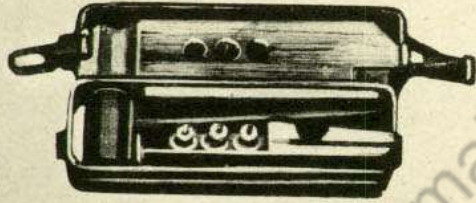

2



3

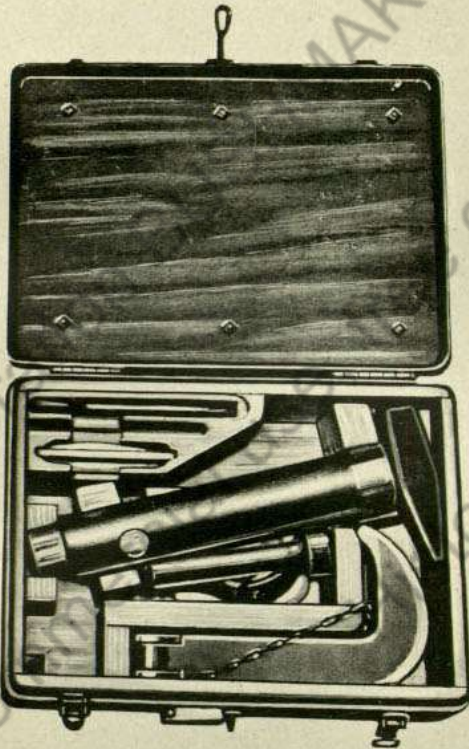

4

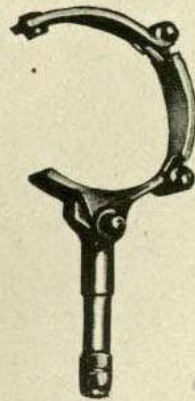

5

Gruppe: Werkzeug mit Zubehör

TAFEL 78

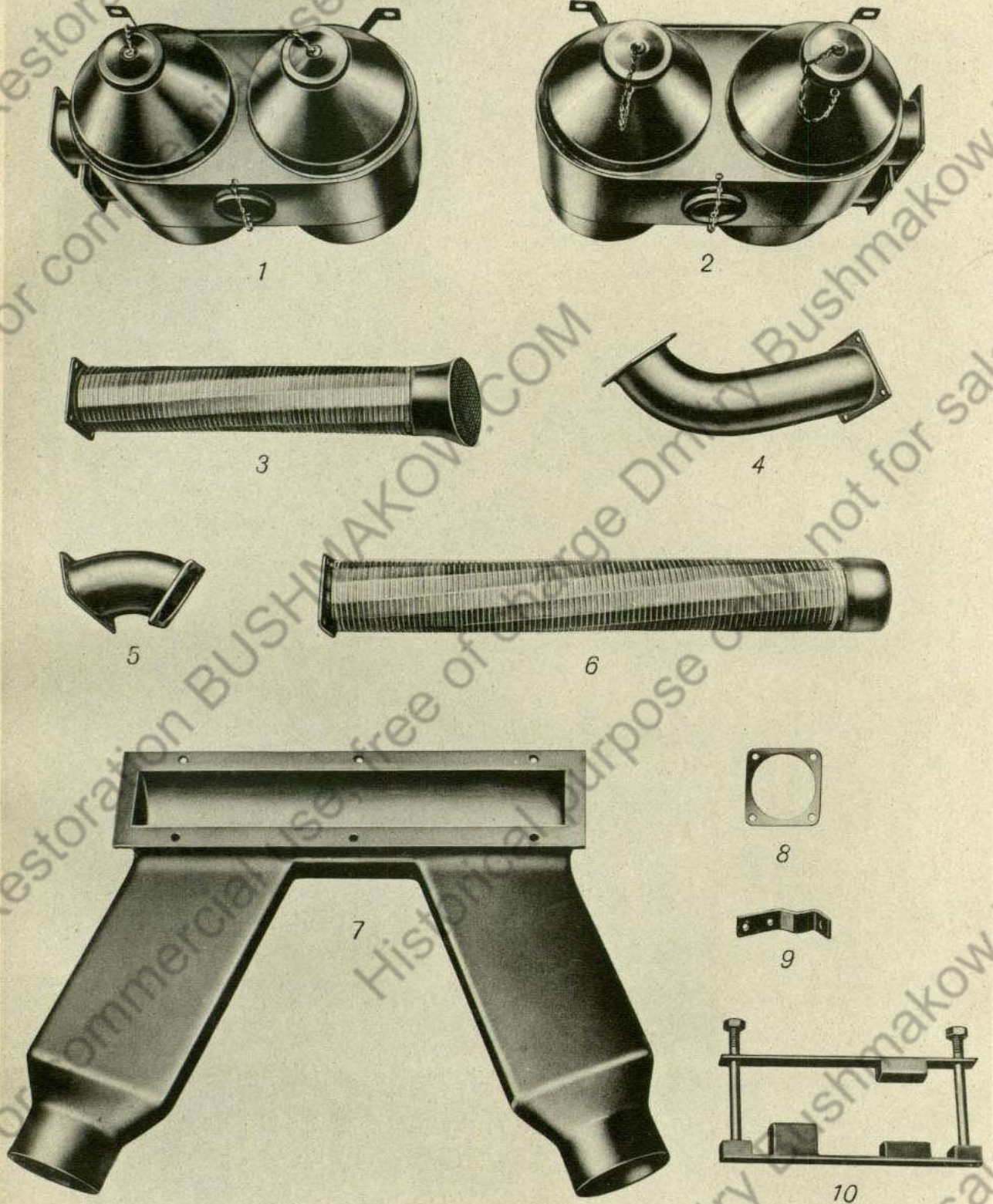

Gruppe: Kühlanlage (Wasserwirbler)

TAFEL 79

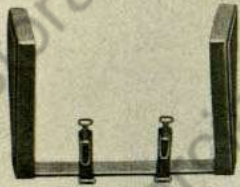

1

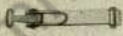

2

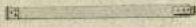

2a



3

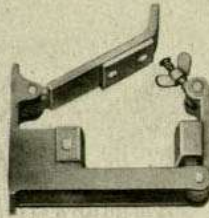

4

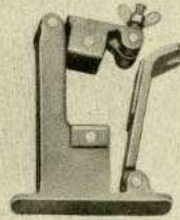

5



6



7



8



9

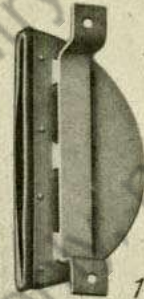

10



11



12

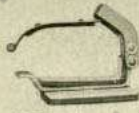

13



14



15



16



17



18



19



20



21



22



23



24



25

Gruppe: Halterungen

TAFEL 80

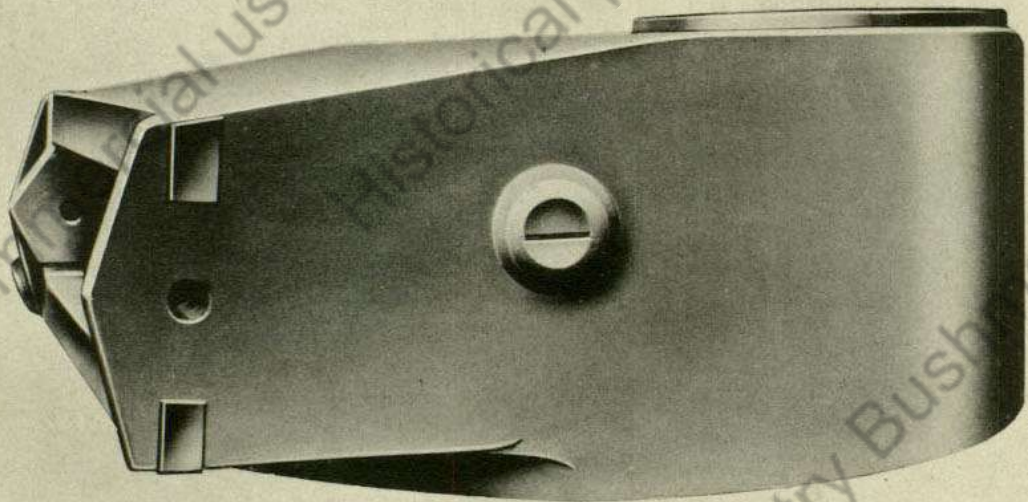
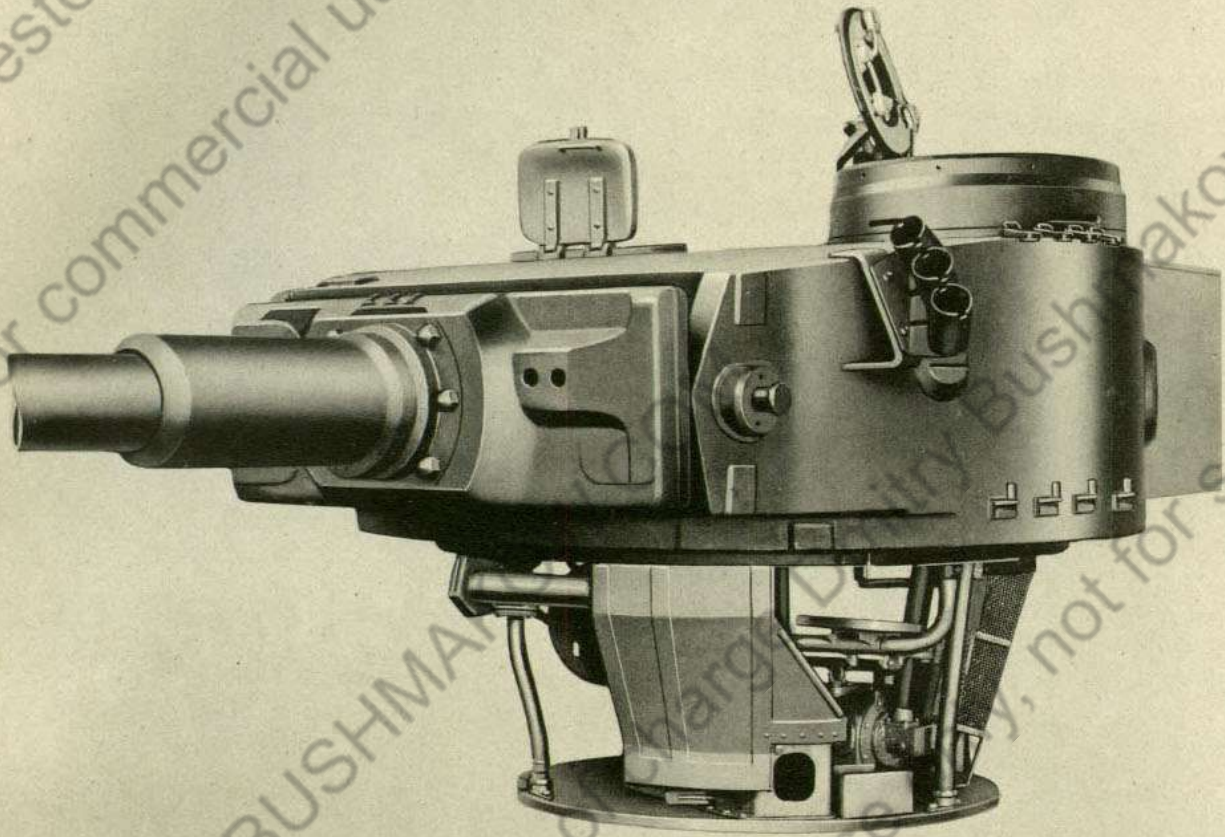

2

Gruppe: Drehturm

TAFEL 81

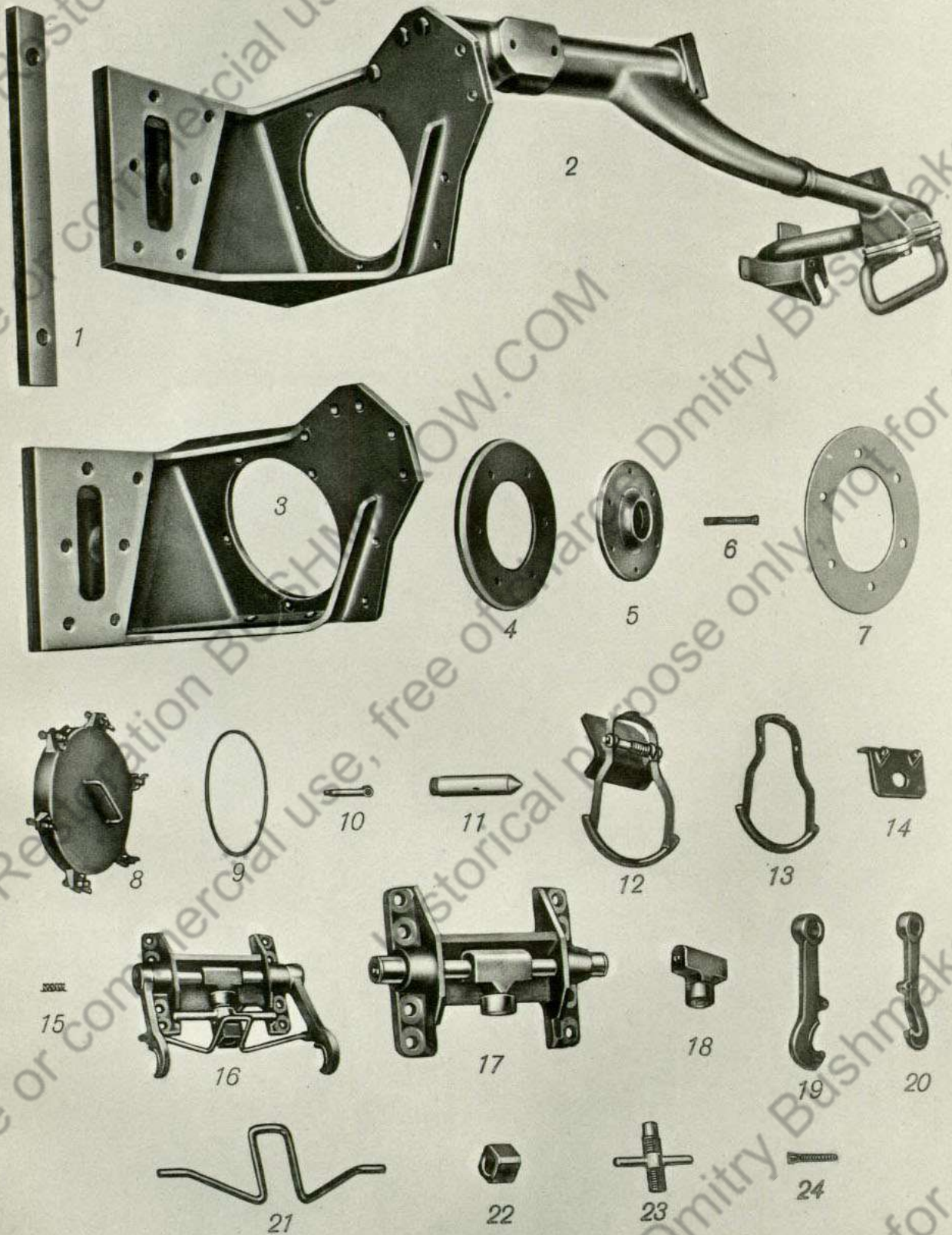

Gruppe: Drehturm [(2.) Einbauteile]

TAFEL 82

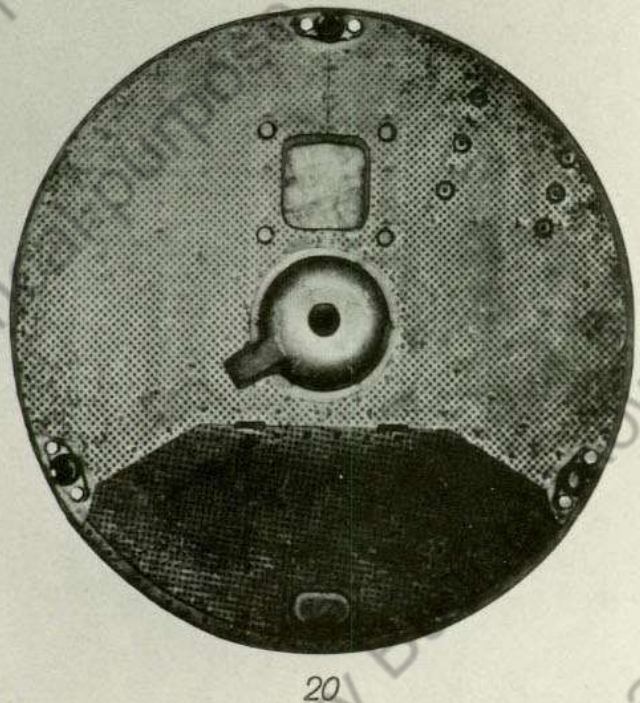
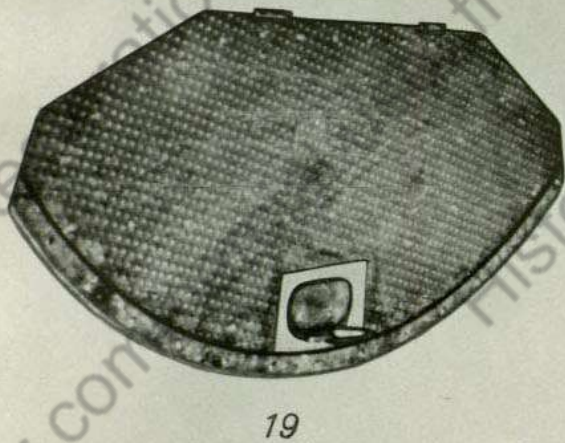
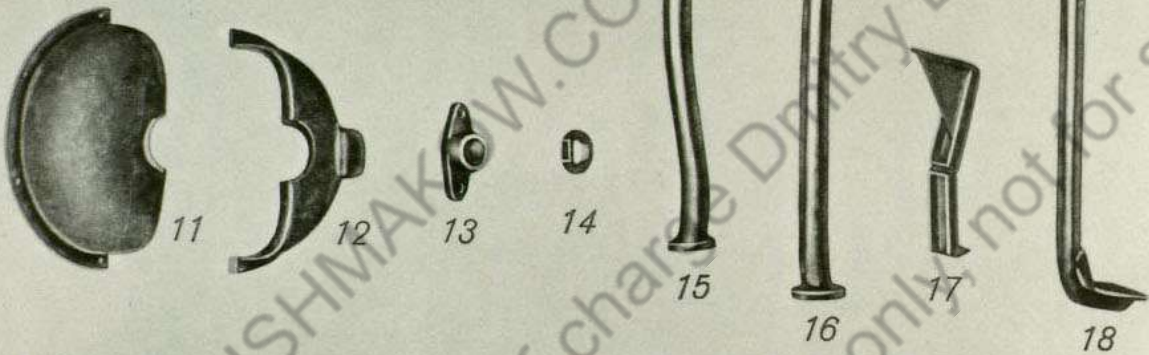
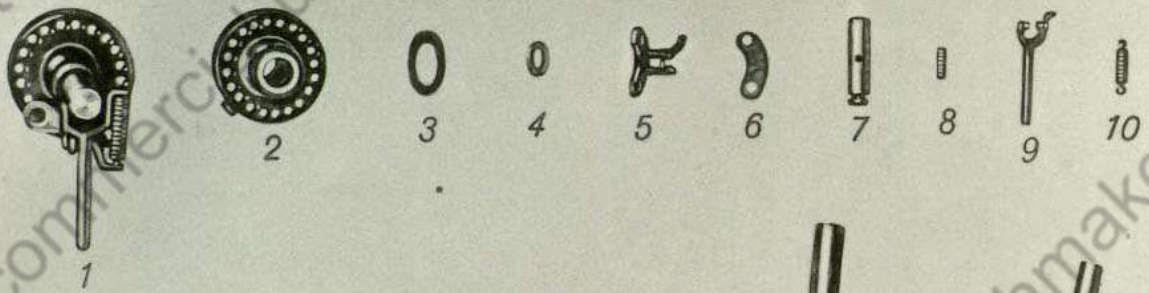

Gruppe: Drehturm [(4b) Zurrungen (Bild 1-10)]
 Gruppe: Drehturm [(5.) Drehbühne (Bild 11-20)]

TAFEL 83

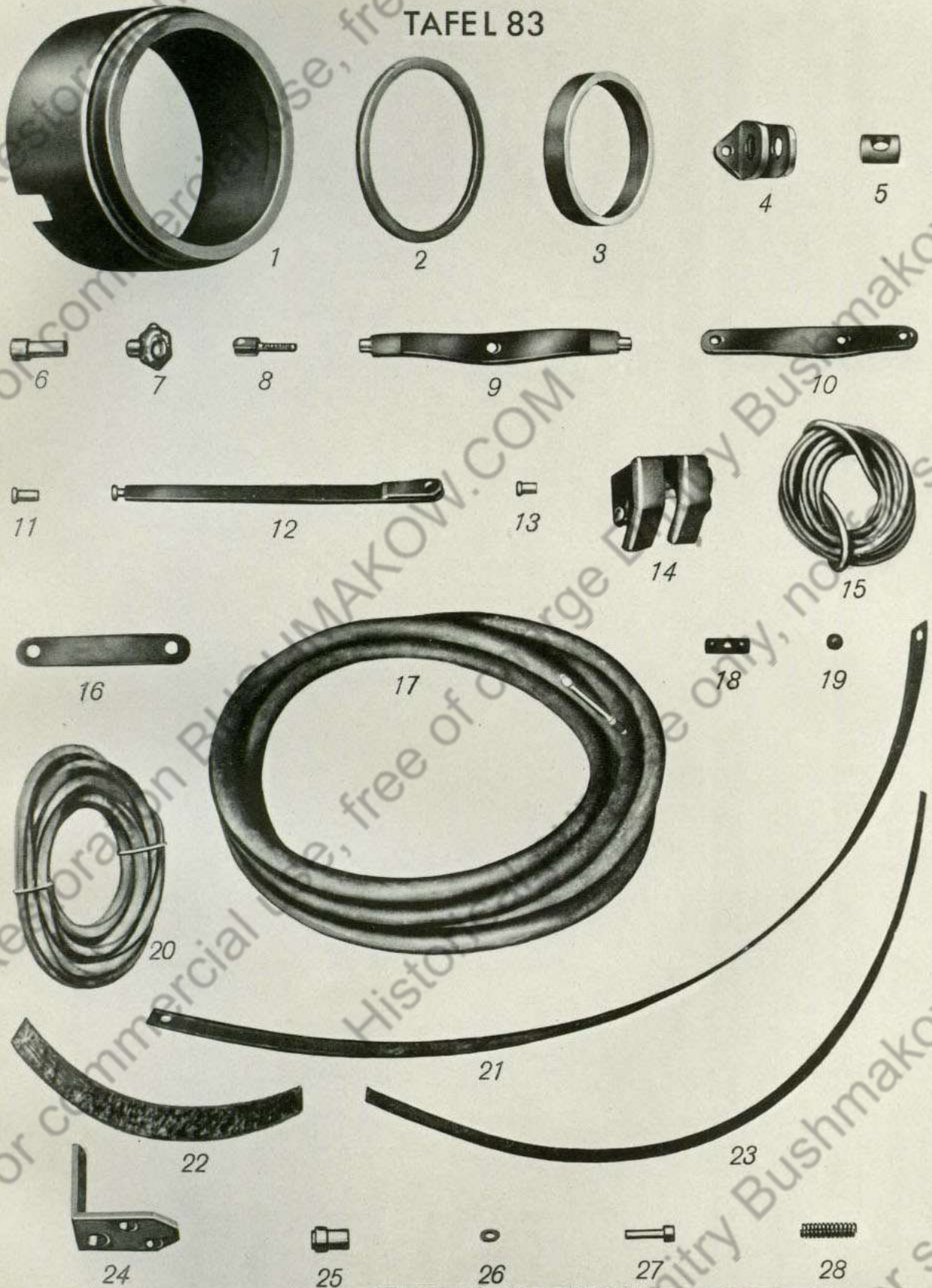

Gruppe: Drehturm [(6.) Wiegenabdichtung (Bild 1-13)]
 Gruppe: Drehturm [(2.) Einbauteile (Bild 14)]
 Gruppe: Kugelbahn (Bild 15-28)

TAFEL 84

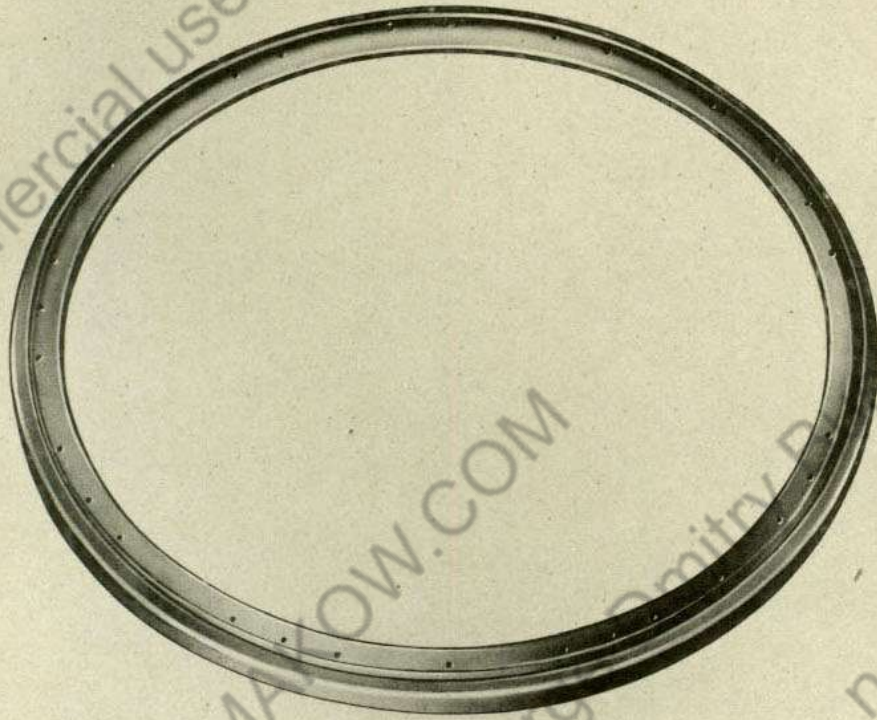

1

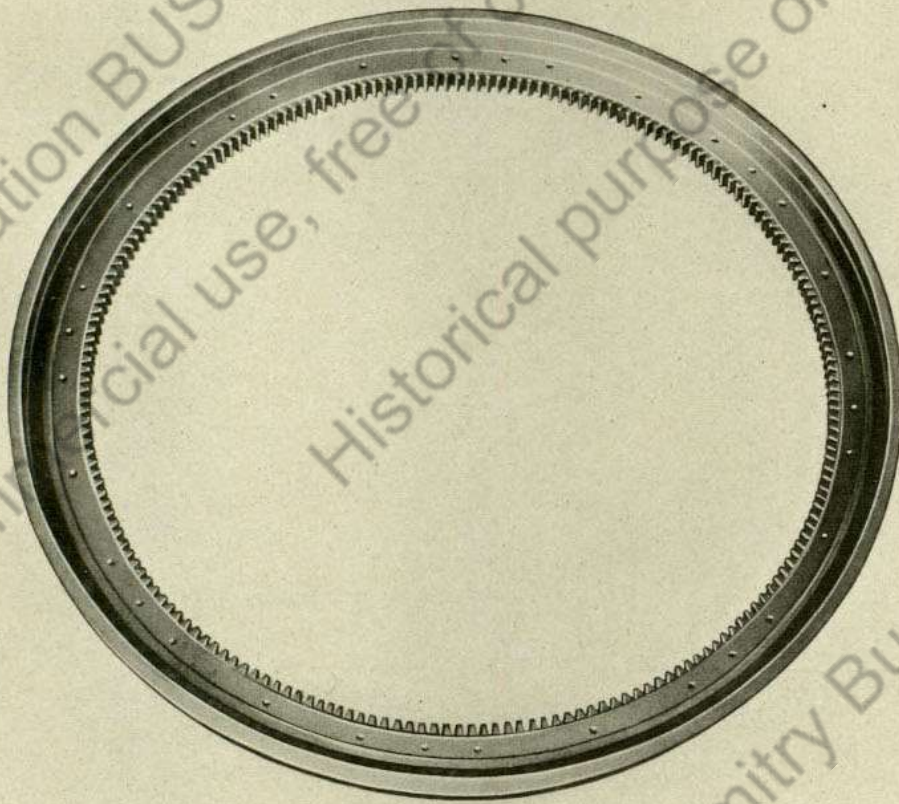

2

Gruppe: Kugelbahn

TAFEL 85



1

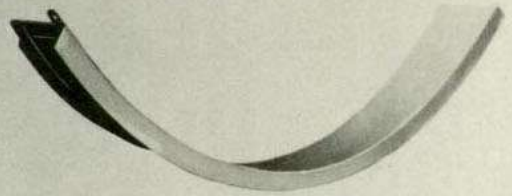

2

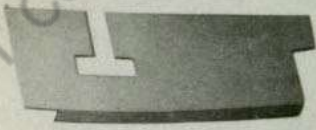

3



4



5

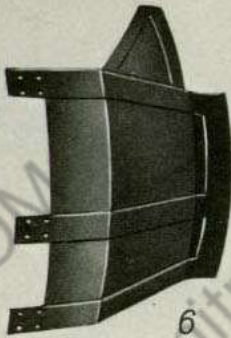

6



7

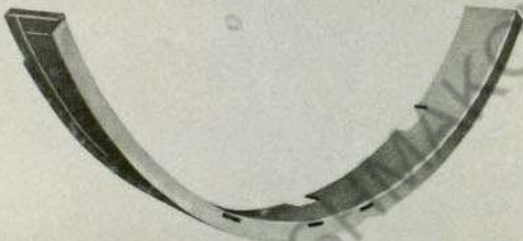

8



9



10



11



12



13



14



15

Gruppe: Kugelbahn

TAFEL 86

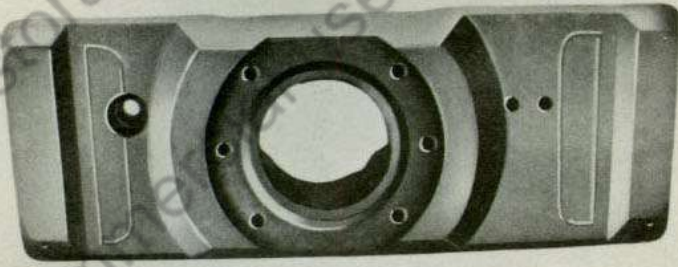

1



2



3



4

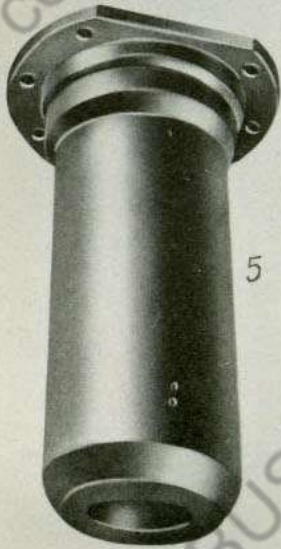

5



6



7



8



9

10

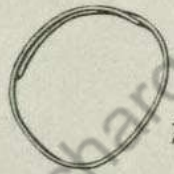

11



12



13



14



15



16



17

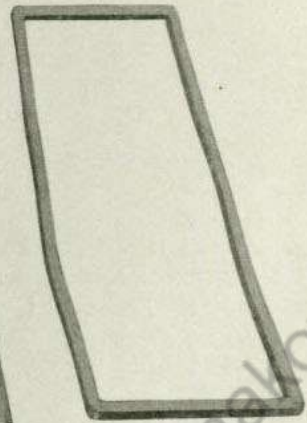

18



19



20



21



22



23



24

Gruppe: Walzenblende [(1.) Walzenblende (Bild 1-13)]
 [(2.) Walzenabdichtung (Bild 14-24)]

TAFEL 87



1

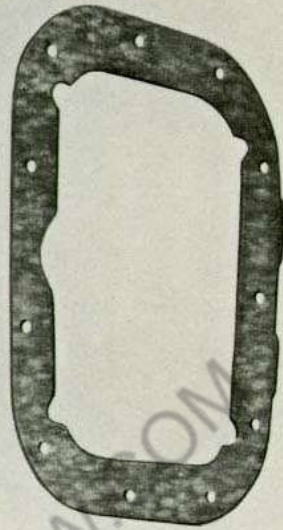

2



3

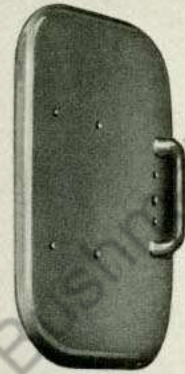

4



5



6



7

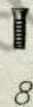

8



9



10



11



12



13



14



15



16



17



18



19



20



21



22

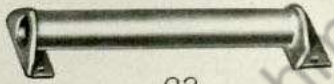

23

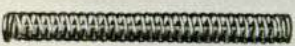

24



25



26



27



28

Gruppe: Lukendeckel

TAFEL 88

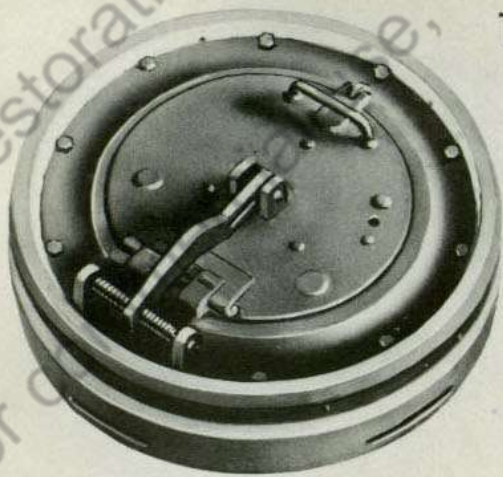

1

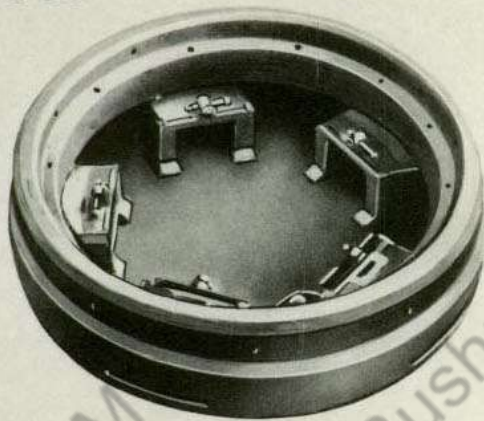

2

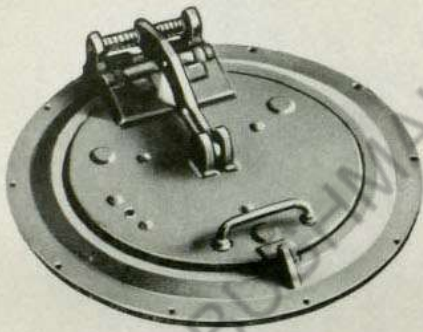

3

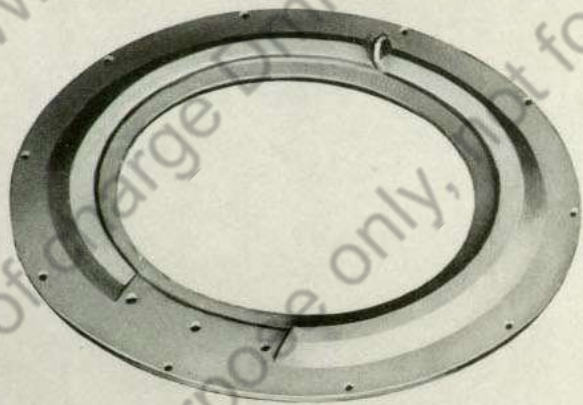

4



5

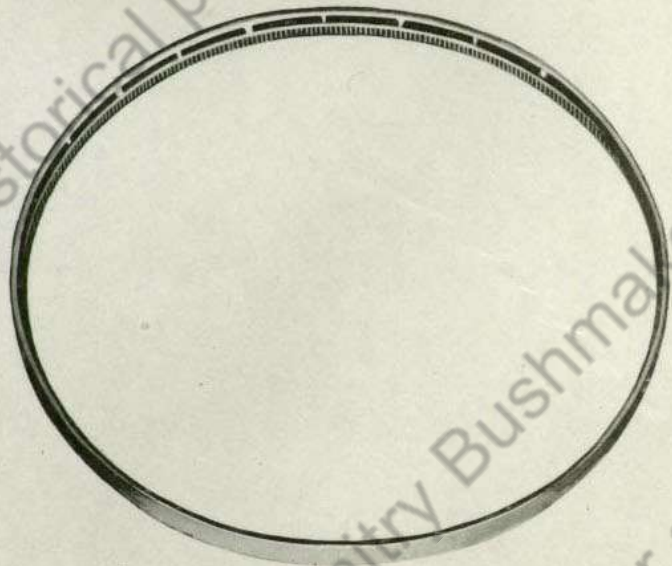

6

Gruppe: Kommandantenkuppel

TAFEL 89

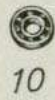
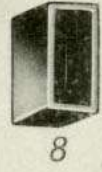

Gruppe: Kommandantenkuppel

TAFEL 90

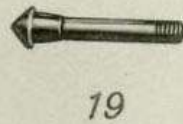
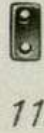
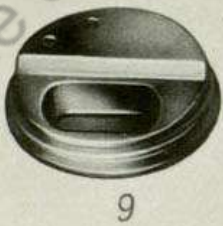
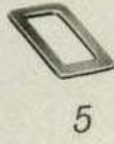
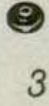

Gruppe: Sehklappen [(1.) Sehschlitzplatten (Bild 1-8)]
[(2.) MP-Klappen (Bild 9-25)]

TAFEL 91

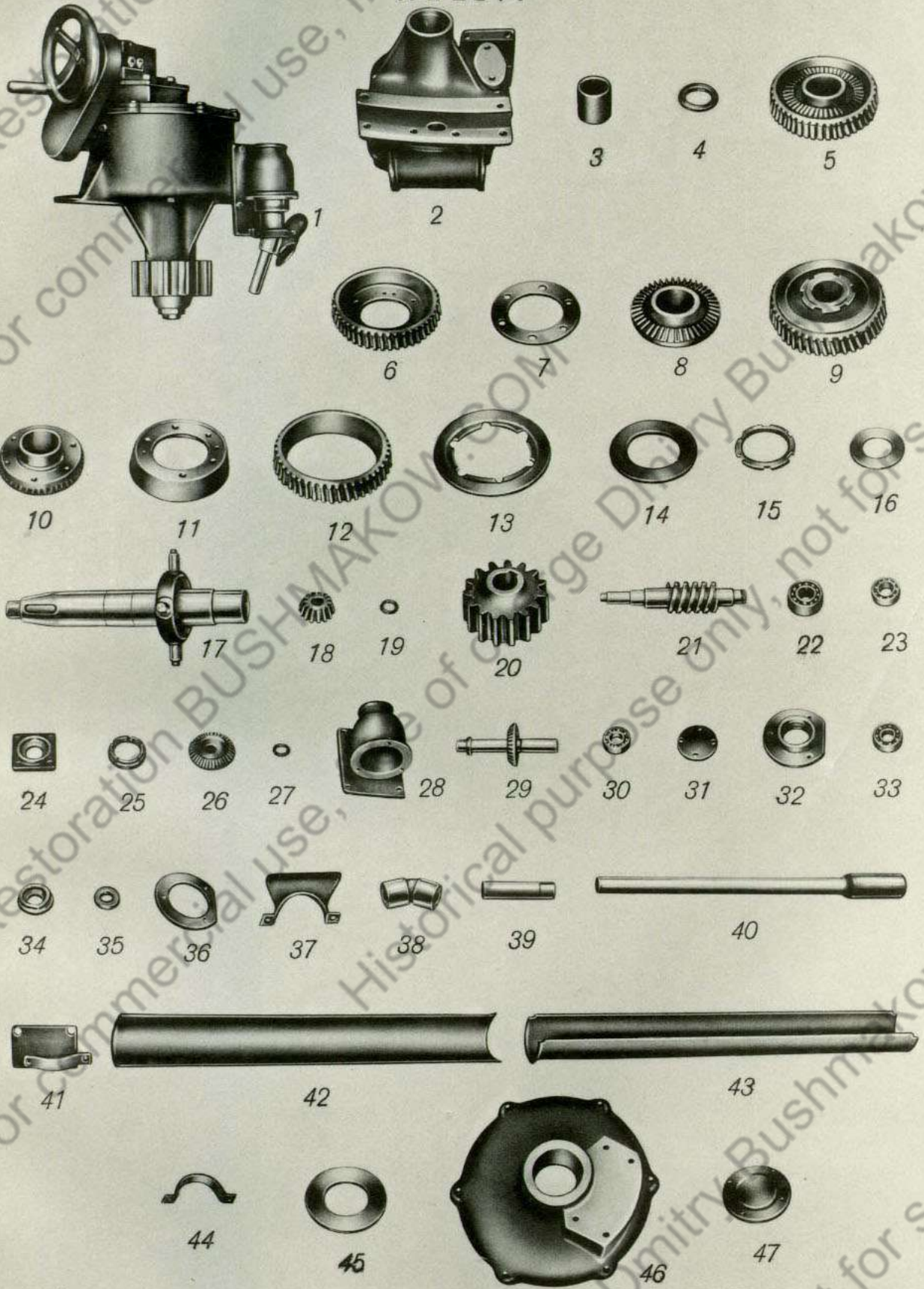

Gruppe: Turmschwenkwerk

TAFEL 92

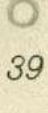
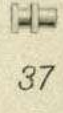
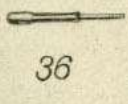
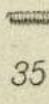
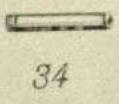
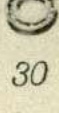
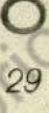
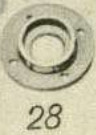
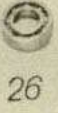
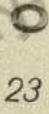
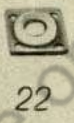
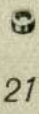
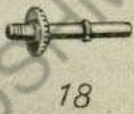
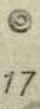
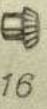
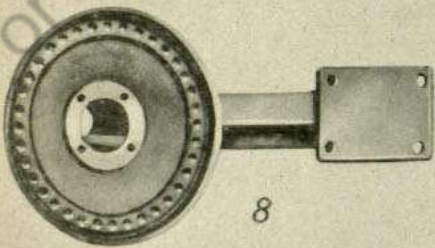
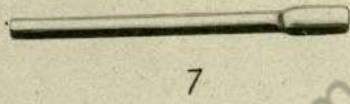
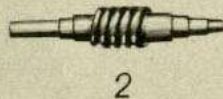
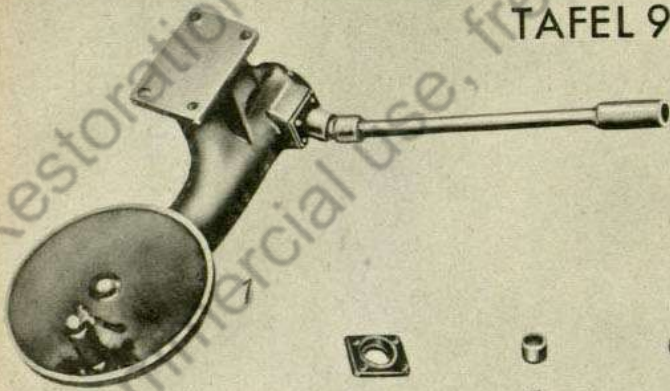

40
Gruppe: Turmschwenkwerk

TAFEL 93

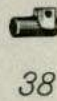
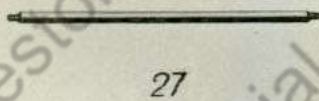
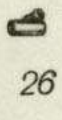
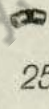
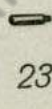
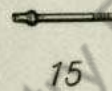
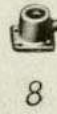

Gruppe: Turmschwenkwerk (Bild 1-11)
 Gruppe: 12-Uhrzeigerantrieb (Bild 12-27)
 Gruppe: Richtungsanzeiger (Bild 28-40)

TAFEL 94

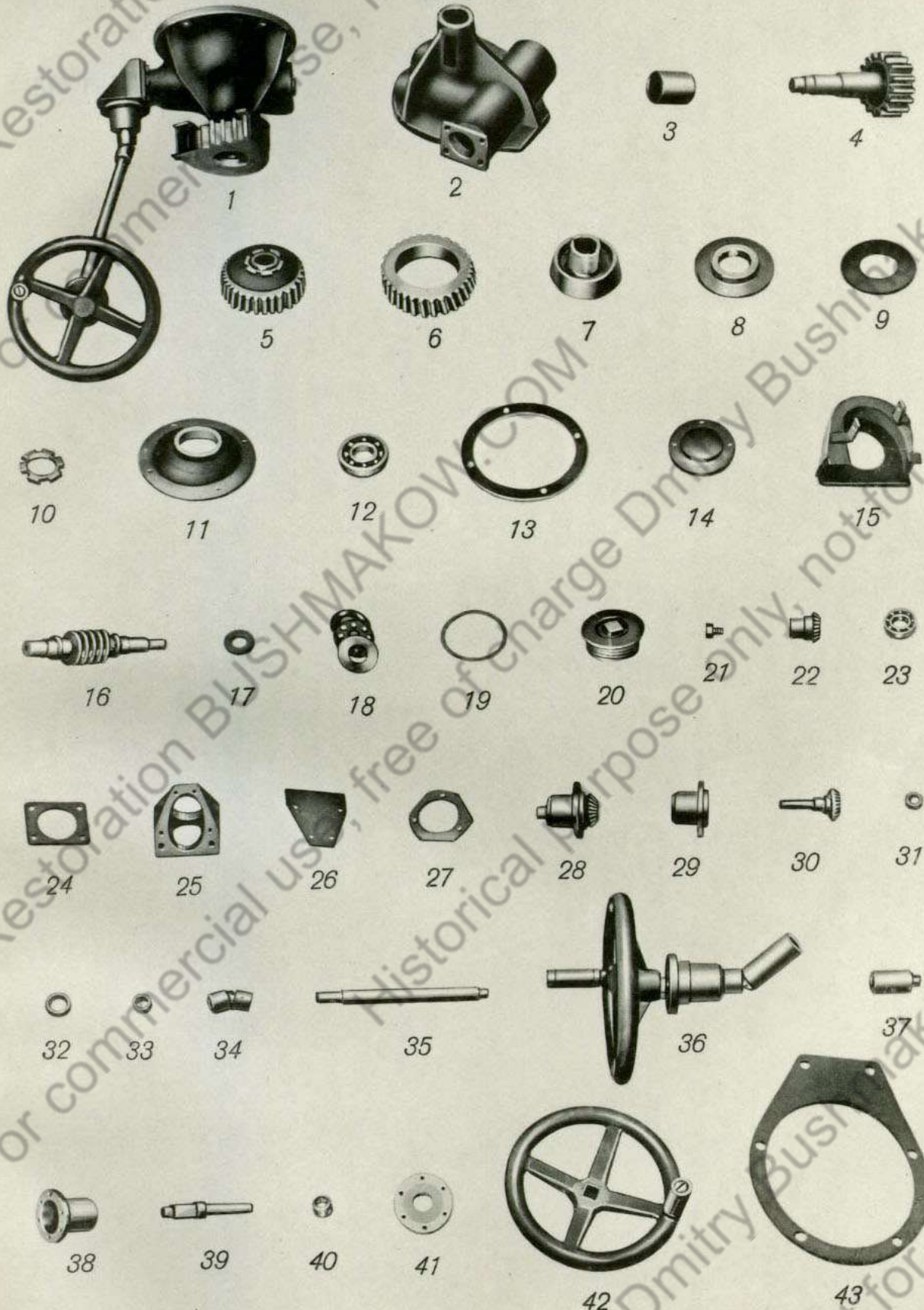

Gruppe: Höhenrichtmaschine

TAFEL 95

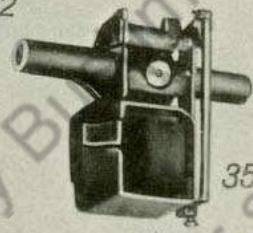
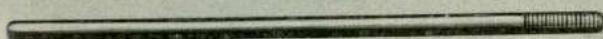
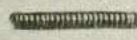
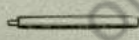
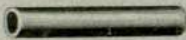
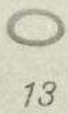
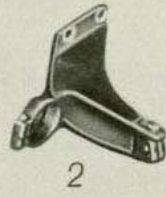
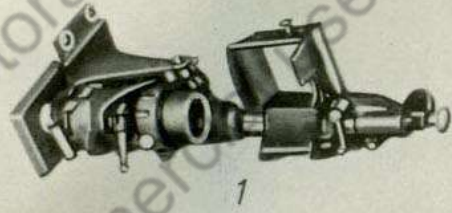

Gruppe: MG-Lagerung

TAFEL 96

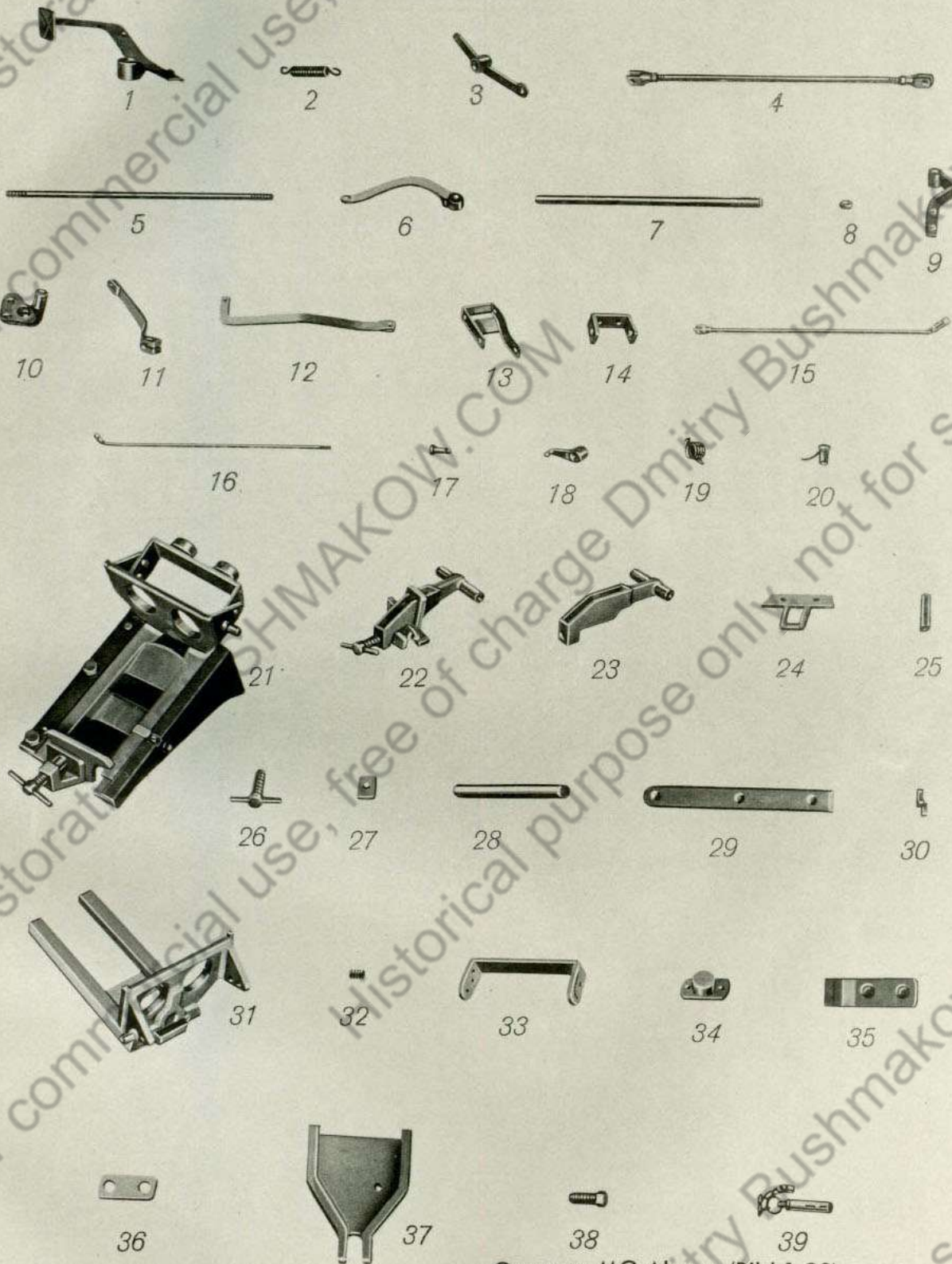

Gruppe: MG-Abzug (Bild 1-20)

Gruppe: Lagerung für Optik (Bild 21-39)

TAFEL 97



1



2

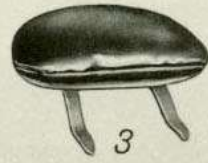

3



4

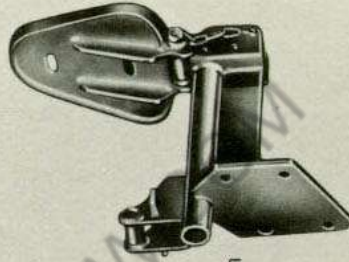

5



6



7



8



9



10



11



12



13



14



15

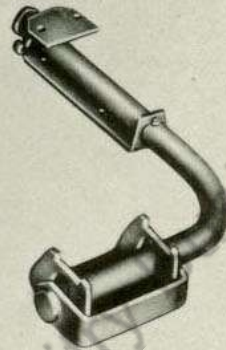

16

Gruppe: Sitze

TAFEL 98

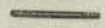
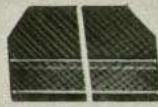
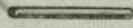
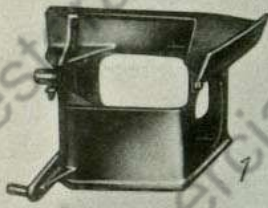

2

3

4

5

6



7

8

9

10

11

12

13

14

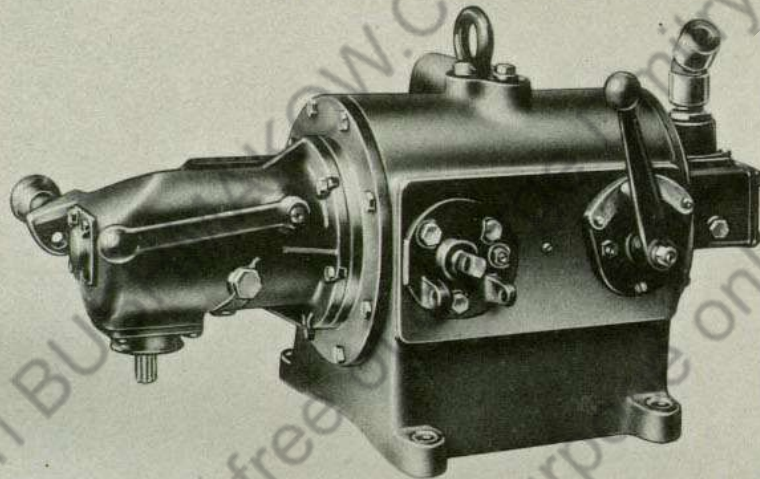

15

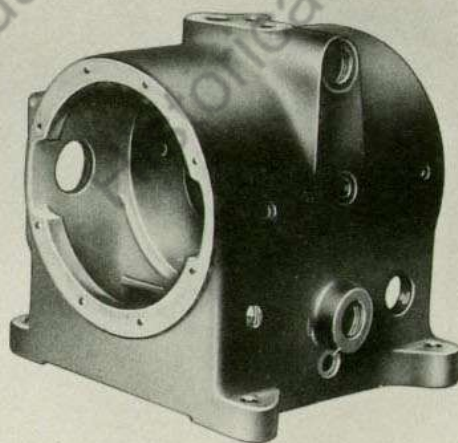

16

Gruppe: Steuerung zum Flüssigkeitsgetriebe (Bild 1-14)
Gruppe: Flüssigkeitsgetriebe (Bild 15-16)

TAFEL 99

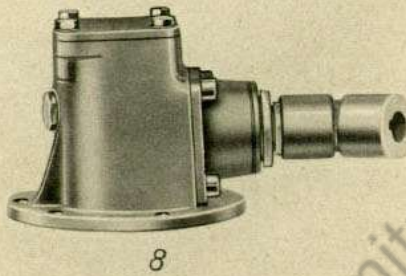
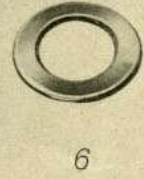
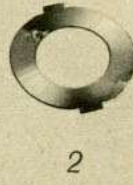
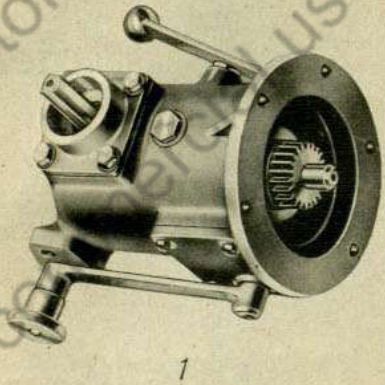

Gruppe: Flüssigkeitsgetriebe

TAFEL 100

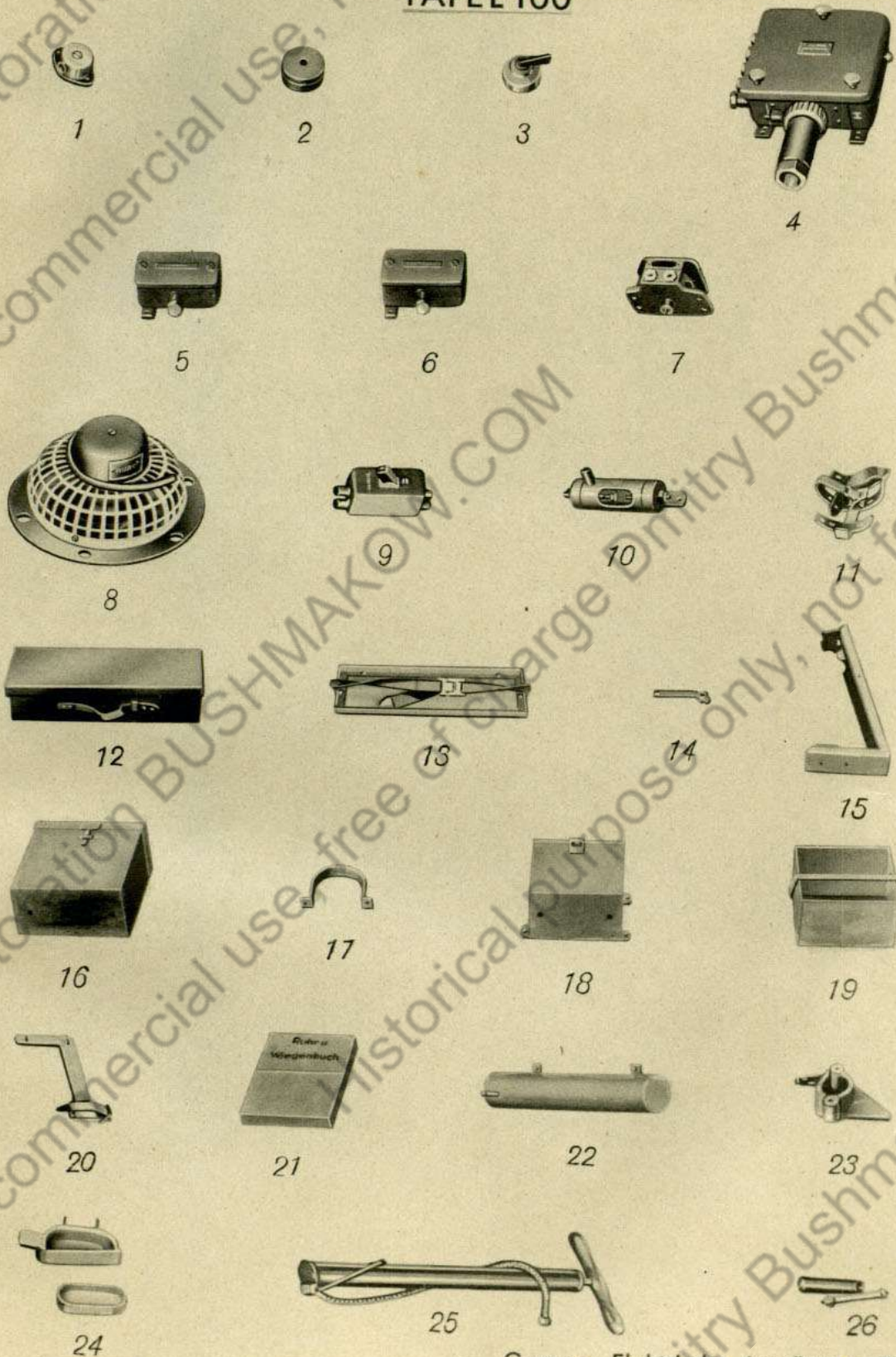

Gruppe: Elektrische Ausrüstung (Bild 1-10)

Gruppe: Zubehörlagerung (Bild 11-26)

TAFEL 101

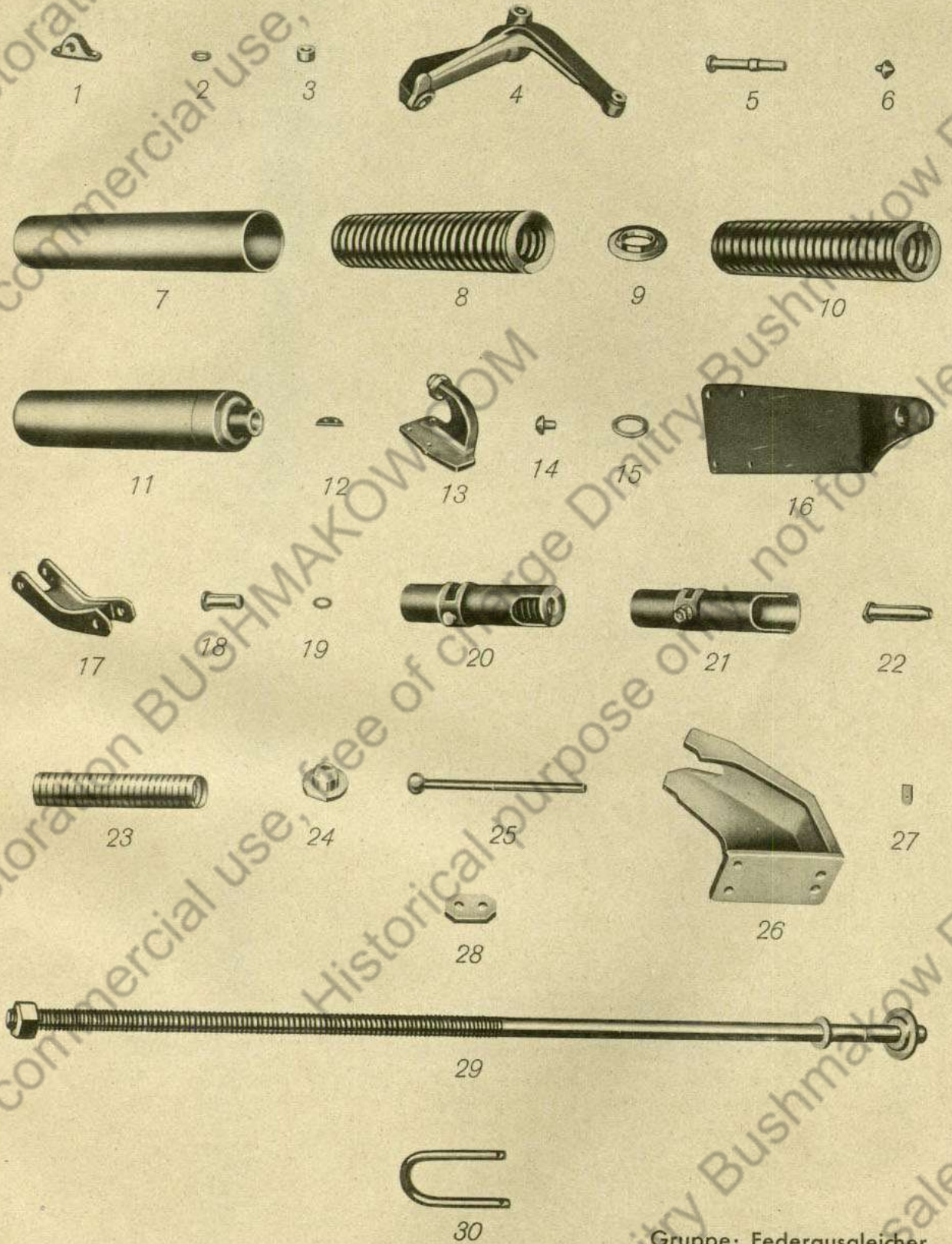

Gruppe: Federausgleicher

